



|  |           |
|--|-----------|
| <b>About D-Line</b>                                      | <b>3</b>  |
| <b>About D-Line Trunking</b>                             | <b>4</b>  |
| <b>Trunking Features &amp; Benefits</b>                  | <b>5</b>  |
| <b>Trunking Case Study</b>                               | <b>6</b>  |
| <b>Specifying D-Line Trunking &amp; Safe-D Clips</b>     | <b>7</b>  |
| Micro Trunking - 16mm x 8mm                              | <b>8</b>  |
| Micro+ Trunking - 20mm x 10mm                            | <b>9</b>  |
| Mini Trunking - 30mm x 15mm                              | <b>10</b> |
| Maxi Trunking - 50mm x 25mm                              | <b>11</b> |
| ¼ Round Trunking - 22mm x 22mm                           | <b>12</b> |
| Surface Boxes  | <b>14</b> |
| Trunking Adaptors Guide                                  | <b>16</b> |
| Accessories Fitting Guide                                | <b>19</b> |
| Trunking & Accessories Product Codes                     | <b>20</b> |
| Trunking Guide   | <b>22</b> |
| Accessories Guide  | <b>23</b> |
| <b>About The Safe-D Range</b>                            | <b>24</b> |
| Safe-D Range Features and Benefits                       | <b>25</b> |
| Safe-D U-Clip 30 - Fire Rated Clips                      | <b>26</b> |
| Safe-D Red U-Clip 30 - Fire Rated Clips                  | <b>27</b> |
| Safe-D U-Clip 40 - Fire Rated Clips                      | <b>28</b> |
| Safe-D U-Clip 50 - Fire Rated Clips                      | <b>29</b> |
| Safe-D F-Clip 30- Fire Rated Clips                       | <b>30</b> |
| Safe-D F-Clip 40- Fire Rated Clips                       | <b>31</b> |
| Safe-D F-Clip 50- Fire Rated Clips                       | <b>32</b> |
| Safe-D Spring Clip                                       | <b>33</b> |
| Safe-D Retro Clips                                       | <b>34</b> |
| Safe-D 20mm + 25mm Conduit Saddles                       | <b>35</b> |
| Safe-D Adjustable XLPE/SWA Cable Clips                   | <b>36</b> |
| Safe-D Stag Clips  | <b>37</b> |
| Safe-D D-Fixing  | <b>38</b> |
| <b>About Cable Safety Products</b>                       | <b>40</b> |
| FC68B Medium Duty Floor Protector                        | <b>41</b> |
| FC83B Medium Duty Floor Protector                        | <b>42</b> |
| FC83H Medium Duty Floor Protector                        | <b>43</b> |
| FC83B/2C/9M Medium Duty Floor Protector                  | <b>44</b> |
| CGS3B Cable Grip Strip                                   | <b>45</b> |
| DO-1B765 & DO-2B765 Rigid Single Channel Cable Protector | <b>46</b> |
| Socket Enclosures  | <b>47</b> |
| Cable Zipper   | <b>48</b> |
| Split Cable Tube   | <b>49</b> |
| Cable Spiral Wrap  | <b>50</b> |
| Cable Tidy Band  | <b>51</b> |





## About D-Line

**D-Line is a UK company, based in Newcastle upon Tyne, with a global reputation for innovative cable management products 'for use where time, safety and appearance matter'.**

In 2004 D-Line patented single-piece trunking systems in subtle shapes that blend with modern decor. These D-shaped ½ round & ¼ round profiles are now popular in 30+ countries. As often said 'the finishing touch of a D-Line installation creates a lasting impression'; preferred by specifiers, installers and clients.

D-Line also invented the first fire-rated clips that could be fitted in non-metallic trunking, so preventing the potentially fatal consequences of cable entanglement.

With a commitment to innovation, D-Line have developed Socket Enclosures to contain socket extensions and cable

clutter, and pioneered linkable Floor Cable Protectors to satisfy another common requirement.

In 2016 D-Line launched The Cable Safety at Work Campaign - advising of cable-hazards, legislative responsibilities, and preventive product solutions to reduce accidents by addressing Health & Safety cable-risks in workplaces.

Aside other developments, over recent years D-Line's Safe-D range of fire rated cable supports has evolved to include one-piece one-fixing Conduit Clips, F-Clips (flat, flexible & fire rated), adjustable Spring Clips to hold cables in tight spaces, fire rated D-Fixing screws, Retro Clips and more!

D-Line products are manufactured in the UK to most exacting standards. They are fully tested and certified to highest quality requirements.

“ D-Line trunking is our preferred way to route cables... compared to chasing walls, or standard mini-trunking, it makes a better choice all round! ”



***The modern way to hide cables...***

# About D-Line Trunking

The World's Fastest Trunking System



## The modern way to hide cables...



**D-shaped and linear, D-Line is named after the iconic style of our first products. The single-piece design, complementary accessories and subtle shapes combine so that D-Line trunking is 'quick to install and looks great!'**

Compared to channelling walls or lifting floors to contain cables, D-Line appreciate how surface trunking installations can save huge amounts of time and cost, while minimising inconvenience; and thereafter protect cables for on-going peace of mind.







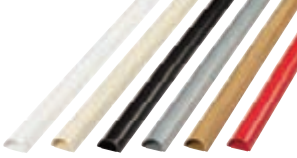

It follows that D-Line trunking is an inexpensive and practical alternative to **either** channelling walls **or** traditional trunking products.

At D-Line we respect also that for I.T. and Datacoms, electrical upgrades, Fire & Security, and many HVAC

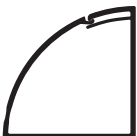
and Audio Visual projects, the equipment will often be the most costly expenditure, but, for a surface installation, the trunking will usually be the most conspicuous element...

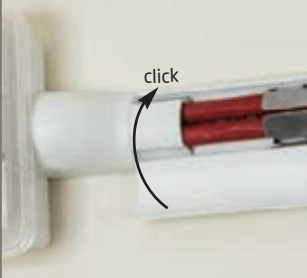
D-Line enables a quality of finish to complement the interior design of modern spaces, in stylish ways that are obvious to all stakeholders. As often said using D-Line cable trunking 'cables seem to disappear' and 'the finishing touch of a D-Line cable management installation makes a lasting impression.'

Choose from eight profiles according to the volume of cables to be contained. A choice of colours and full ranges of accessories are available also.

|   | FEATURE   | BENEFIT  |
|---|---|--|
|    | <b>Designer shapes and colours</b>  | <ul style="list-style-type: none"> <li>• Designs give subtle appearance with no sharp edges; to blend with contemporary surrounds - or colour options to provide a striking feature!</li> </ul>  |
|    |  | <ul style="list-style-type: none"> <li>• Alternative sizes satisfy popular demands Available as (width x height) 16x8mm, 20x10mm, 30x15mm &amp; 50x25mm</li> <li>• Gentle on impact and easy to clean</li> </ul>   |
|    |  | <ul style="list-style-type: none"> <li>• Available (width x height) 22x22mm &amp; 30x30mm</li> <li>• 22x22mm makes the ultimate floor trim!</li> <li>• Can also be used as cornice or coving</li> </ul>  |
|   | <b>PVC</b>  | <ul style="list-style-type: none"> <li>• Self extinguishing</li> <li>• UV stabilised</li> <li>• Lightweight &amp; easy to cut</li> <li>• Stable between -30°C to +60°C</li> <li>• Satisfies BS EN 50085-1:2005</li> </ul>  |
|  | <b>Patented hinge &amp; click-lock lid</b>  | <ul style="list-style-type: none"> <li>• Single-piece design... for quick &amp; easy handling</li> <li>• Only one cut (no need to separately cut base, and lid, before fitting accessories)</li> <li>• Lids will never peel or detach - maintenance friendly</li> <li>• Tensioned hinge provides a cable retainer to keep cables in position during installation</li> <li>• Easy to later add or remove cables</li> <li>• User friendly in tight spaces</li> <li>• Hinge acts as a shock absorber on impact</li> </ul> |
|  | <b>Film covered lengths</b>   | <ul style="list-style-type: none"> <li>• Keeps lengths pristine before installation</li> <li>• Environmentally friendly packaging</li> </ul>   |
|  | <b>Self-adhesive foam backing</b>   | <ul style="list-style-type: none"> <li>• Simply peel &amp; stick - Quick &amp; easy to install</li> <li>• Can be drilled also</li> </ul>   |
|  | <b>Easy to use Ratchet Cutting Tool</b>   | <ul style="list-style-type: none"> <li>• Use to cut up to 40mm wide D-Line Trunking</li> <li>• No dust residue</li> <li>• Quick &amp; clean cutting action</li> </ul>  |
|  | <b>Paintable</b>  | <ul style="list-style-type: none"> <li>• Can blend with any decor</li> </ul>   |

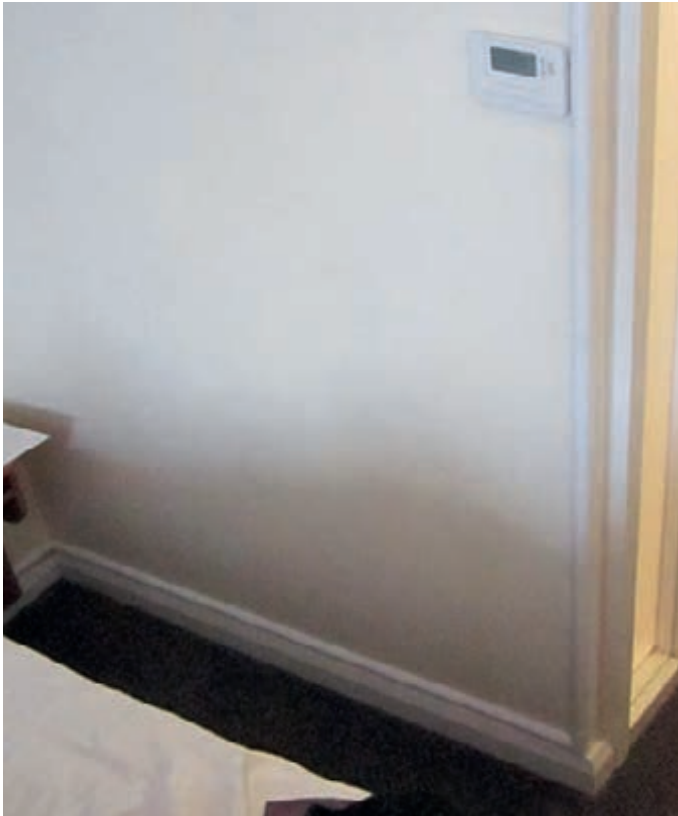

## When 20,000 hotel rooms needed to hide cables for new heating controllers, D-Line Mini Trunking proved the perfect choice...

Using D-Line saved a small fortune compared to the cost of channelling the walls, then needing to co-ordinate works to re-plaster and re-decorate.

Aside the noise and disruption, trying to recess the cabling would have put rooms out-of-service. However traditional trunking did not look suitable for a hotel chain with a reputation for comfort and style.

Cables from wall mounted heaters to wall mounted controllers were concealed in D-Line Mini Trunking which blended with the skirting, and, when necessary, up-and-around bedheads.

A cut-length rose up to the heater via a Clip-Over Equal Tee, while Clip-Over Internal Bends made internal corner connections quick and easy. The Flat Bend required was the Smooth-Fit version, as the secure internal tabs were

favoured to eliminate future maintenance concerns, given that this part was most likely to be bumped by guests' baggage.

The ½ round shape of the length rising up to the wall-mounted controller was preferred also for its impact resistance, the lack of sharp edge a distinct benefit (compared to traditional sharp edge trunking).

The D-Line Cutting Tool was used throughout, saving time and leaving no PVC dust residue.

The self-adhesive tape was used to attach the lengths to the walls, with a screw-fixing and plug then inserted 750mm from each end.

The result was 20,000 installations using 200km - all easy to fit, quick to install and blending with decor.

**Further details on request.**

### Unique Clip-Over Accessories

### Saves Channelling Walls

### Quick and Easy to Fit





**To specify D-Line ½ round Trunking:** ½ round Trunking, produced using self-extinguishing PVC with non-detachable hinged & click-lock lid in a single piece design, as compliant with BS EN 50085 - 1:2005 Part 1. Use with proprietary accessories.

**To specify Safe-D Clips:** High-temperature (1200°C) pliable-steel fire-rated clips with non-corrosive finish, 20mm wide fold-over tabs with rounded top edges. Compliant with BS7671 wiring regulations & BS5839-1 requirements. After checking compatibility of the substrate, use with fire rated fixings to secure Safe-D Clips.

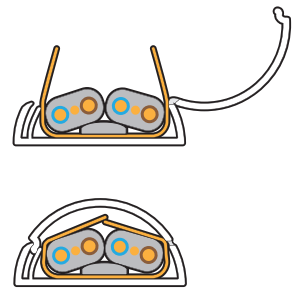

## Compared to channelling walls, using D-Line Trunking and Safe-D Clips can save up to 70% on installation costs...

- Disruption is minimized (reduced noise and mess)
- Saving need to co-ordinate several trades (e.g. plastering, decorating etc)
- On-going assured cable protection

## Compared to other trunking/clip systems, using D-Line Trunking and Safe-D Clips can save up to 33% labour time and costs...

- Single piece design (one piece to handle/cut)
- Simply fit, fix and fold Safe-D Clips to secure cables
- On-going appearance that blends with decor



Making channels in walls, lifting floors, or using ceiling voids to hide cables can be awkward and disruptive, while repairs require co-ordination with other trades.

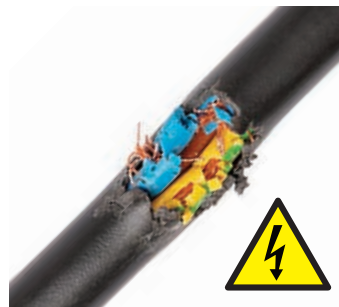

Cables can be vulnerable in cavities e.g. rodents gnawing insulation; careless drilling or nailing - and future access to the installation is most difficult.



Two pieces to handle, awkward to install, lids can detach to create on-going maintenance demands.

Blocky sharp-edged white plastic strips can look unfashionable in modern decor.



Inadequately supported cables pose risk of potentially fatal entanglements in fire conditions.

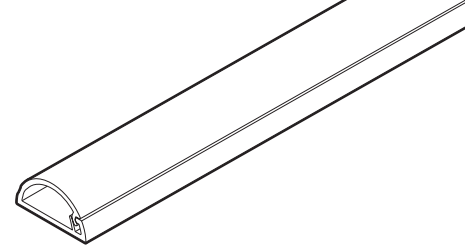

## Micro Trunking 16mm x 8mm

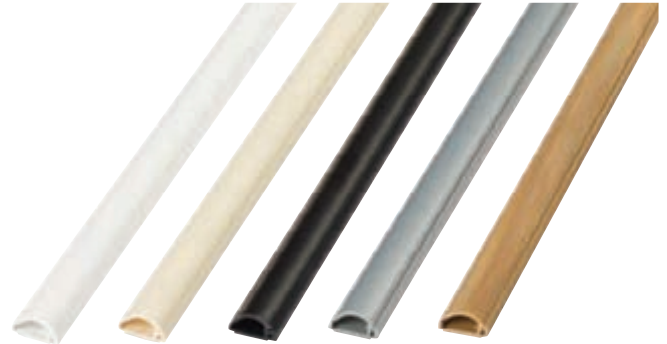

**To hide speaker cable, bell wires, telephone and alarm cable, Micro Trunking offers a discreet solution.**

Available in a choice of colours and with a range of Smooth-Fit accessories; the flush design gives a neat appearance.

The 16 x 8mm dimensions give options in the tightest of spaces.

- Micro profile, only 16x8mm (WxH)
- Patented hinge & click-lock lid
- Paintable
- Smooth-Fit accessories available for perfect finish
- 'Easy to install, looks great!'
- Self-adhesive, or can be drilled & screw-fixed
- Fully safety tested and certified to BS EN 50085-1:2005
- If required, cable retaining Safe-D Spring Clips can be fitted internally

| Code     | Description                 | Colour           |
|----------|-----------------------------|------------------|
| R2D1608W | (L) 2m x (W) 16mm x (H) 8mm | White            |
| R3D1608W | (L) 3m x (W) 16mm x (H) 8mm | White            |
| R2D1608M | (L) 2m x (W) 16mm x (H) 8mm | Magnolia         |
| R3D1608M | (L) 3m x (W) 16mm x (H) 8mm | Magnolia         |
| R2D1608A | (L) 2m x (W) 16mm x (H) 8mm | Aluminium Effect |
| R3D1608A | (L) 3m x (W) 16mm x (H) 8mm | Aluminium Effect |
| R2D1608B | (L) 2m x (W) 16mm x (H) 8mm | Black            |
| R3D1608B | (L) 3m x (W) 16mm x (H) 8mm | Black            |
| R2D1608O | (L) 2m x (W) 16mm x (H) 8mm | Oak Effect       |
| R3D1608O | (L) 3m x (W) 16mm x (H) 8mm | Oak Effect       |



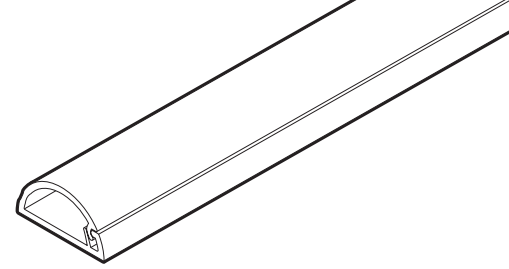

## Micro+ Trunking 20mm x 10mm



**D-Line 20 x 10mm Micro+ profile gives a neat solution for single cables, while offering additional internal capacity that can be useful around corners.**

Complementary Clip-Over bends and tees can provide a perfect finish and are quick & easy to install.

Ideal for flexible cables (up to 8mm outer diameter), also fibre-optic, satellite/aerial and broadband cable installations.

- Discreet and stylish appearance; only 20 x 10mm (WxH)
- Patented hinge & click-lock lid
- Paintable
- Clip-Over accessories available for perfect finish
- 'Easy to install, looks great!'
- Self-adhesive, or can be drilled & screw-fixed
- Fully safety tested and certified to BS EN 50085-1:2005
- If required, cable retaining Safe-D Spring Clips can be fitted internally

| Code     | Description                  | Colour |
|----------|------------------------------|--------|
| R2D2010W | (L) 2m x (W) 20mm x (H) 10mm | White  |
| R3D2010W | (L) 3m x (W) 20mm x (H) 10mm | White  |

**Mini Trunking** 30mm x 15mm

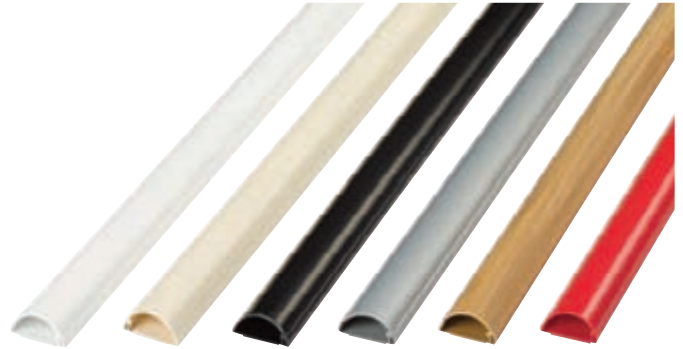
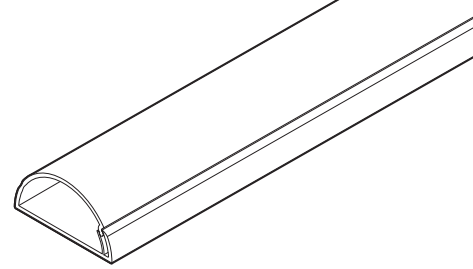

**D-Line 30 x 15mm Mini Trunking offers a subtle appearance to make surface cable installations look attractive!**

The ½ round shape can blend to resemble the natural top-section of skirting boards, while offering a modern solution for vertical cable drops and runs across ceilings.

Available in a variety of colours that can blend with surrounds or create a striking visual feature, this versatile profile is popular for 2x 2.5mm T&E, 2x 1.5mm 2c FP cables, 2x broadband cable and 4x Cat-5 combinations.

- Unique stylish 'D-Line' appearance
- Patented hinge & click-lock lid
- Self-adhesive, or can be drilled & screw-fixed
- Paintable
- Clip-Over & Smooth-Fit accessories for perfect finish
- 'Easy to install, looks great!'
- Adaptors enable popular connections [see page 16/17](#)
- Fully safety tested and certified to BS EN 50085-1:2005
- If required, cable retaining Safe-D Spring Clips can be fitted internally

| Code            | Description                  | Colour           |
|-----------------|------------------------------|------------------|
| <b>R2D3015W</b> | (L) 2m x (W) 30mm x (H) 15mm | White            |
| <b>R3D3015W</b> | (L) 3m x (W) 30mm x (H) 15mm | White            |
| <b>R2D3015M</b> | (L) 2m x (W) 30mm x (H) 15mm | Magnolia         |
| <b>R3D3015M</b> | (L) 3m x (W) 30mm x (H) 15mm | Magnolia         |
| <b>R2D3015A</b> | (L) 2m x (W) 30mm x (H) 15mm | Aluminium Effect |
| <b>R3D3015A</b> | (L) 3m x (W) 30mm x (H) 15mm | Aluminium Effect |

| Code            | Description                  | Colour     |
|-----------------|------------------------------|------------|
| <b>R2D3015B</b> | (L) 2m x (W) 30mm x (H) 15mm | Black      |
| <b>R3D3015B</b> | (L) 3m x (W) 30mm x (H) 15mm | Black      |
| <b>R2D3015O</b> | (L) 2m x (W) 30mm x (H) 15mm | Oak Effect |
| <b>R3D3015O</b> | (L) 3m x (W) 30mm x (H) 15mm | Oak Effect |
| <b>R3D3015R</b> | (L) 3m x (W) 30mm x (H) 15mm | Red        |

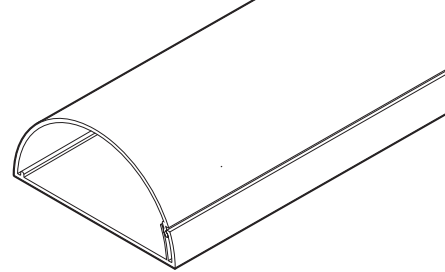

## Maxi Trunking 50mm x 25mm

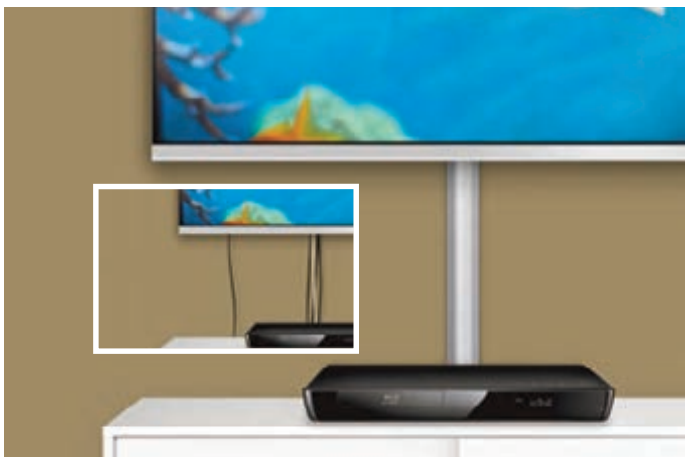

**D-Line 50 x 25mm Maxi is a versatile trunking, providing capacity for several cables.**

A wide range of Clip-Over and Smooth-Fit accessories are available.

The size, capacity and range of colours makes this profile a market-leading solution that is ideal for many AV, electrical and datacoms projects.

- Unique stylish 'D-Line' appearance
- Saves channelling walls
- Self-adhesive, or can be drilled & screw-fixed (as recommended for best practice)
- Clip-Over & Smooth-Fit accessories for perfect finish
- A smart alternative to traditional offers
- No sharp edges, gentle on impact
- Fully safety tested and certified to BS EN 50085-1:2005

| Code     | Description                  | Colour           |
|----------|------------------------------|------------------|
| R2D5025W | (L) 2m x (W) 50mm x (H) 25mm | White            |
| R3D5025W | (L) 3m x (W) 50mm x (H) 25mm | White            |
| R2D5025M | (L) 2m x (W) 50mm x (H) 25mm | Magnolia         |
| R3D5025M | (L) 3m x (W) 50mm x (H) 25mm | Magnolia         |
| R2D5025A | (L) 2m x (W) 50mm x (H) 25mm | Aluminium Effect |
| R3D5025A | (L) 3m x (W) 50mm x (H) 25mm | Aluminium Effect |
| R2D5025B | (L) 2m x (W) 50mm x (H) 25mm | Black            |
| R3D5025B | (L) 3m x (W) 50mm x (H) 25mm | Black            |
| R2D5025O | (L) 2m x (W) 50mm x (H) 25mm | Oak Effect       |
| R3D5025O | (L) 3m x (W) 50mm x (H) 25mm | Oak Effect       |



**D-Line Trunkings make ideal cable organisers for desks**

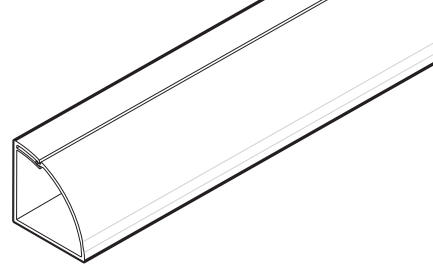

## 1/4 Round Trunking 22mm x 22mm



**1/4 round 22 x 22mm profile covers expansion gaps between floors and skirting. The 22 x 22mm (W x H) dimensions scale well to blend with popular skirting boards, while providing capacity for cable bending radii around corners.**

Traditional floor trim is usually nailed, and requires precise measuring of lengths before corners can be mitre-cut at 45° angles. By contrast D-Line 1/4 round can simply peel-and-stick to skirting, while the Clip-Over corner-bends save any need for precise measuring and can cover oblique cuts.

Compared to regular floor trim, D-Line features combine to enable approximately 50% quicker installations – and then it's easy to add or remove cables!

- Easy to install, looks great!
- Self-adhesive, simply peel & stick to skirting. Also can be drilled & screw-fixed
- Clip-Over or Smooth-Fit corners eliminate the need to mitre-cut
- A smart alternative to traditional floor trims
- Shock-absorbing hinge effect
- A neat cornice option also (see pic above)
- Fully safety tested and certified to BS EN 50085-1:2005
- If required, cable retaining Safe-D Spring Clips can be fitted internally

| Code            | Description                  | Colour         |
|-----------------|------------------------------|----------------|
| <b>R2D22QSW</b> | (L) 2m x (W) 22mm x (H) 22mm | White          |
| <b>R3D22QSW</b> | (L) 3m x (W) 22mm x (H) 22mm | White          |
| <b>R2D22QSO</b> | (L) 2m x (W) 22mm x (H) 22mm | Oak Effect     |
| <b>R2D22QSP</b> | (L) 2m x (W) 22mm x (H) 22mm | Stainable Wood |



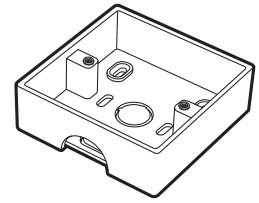

## Single Surface Box 28mm & 35mm Depth



All D-Line Surface Boxes have a unique push-out tab, so for a single entry/exit there is no need to create knockouts!

Note the boxes are malleable, to facilitate the making of cut-outs when any additional entries are required.

Conforming to BS4662, and available in a variety of colours, use with Box Adaptors or Box Adaptor Tees to enable connections in line between vertical and horizontal installations. Please see [page 17](#).

For network outlets and break glass installations requiring additional capacity, 35mm depth white and red surface boxes are available also.



### 35mm Deep Standard Corner Boxes

| Code   | Description                    | Colour |
|--------|--------------------------------|--------|
| SSB35W | (L) 87mm x (W) 87mm x (H) 35mm | White  |
| SSB35R | (L) 87mm x (W) 87mm x (H) 35mm | Red    |

### Rounded Corner Boxes

| Code    | Description                    | Colour |
|---------|--------------------------------|--------|
| SSB28RW | (L) 87mm x (W) 87mm x (H) 28mm | White  |
| SSB35RW | (L) 87mm x (W) 87mm x (H) 35mm | White  |

### 28mm Deep Standard Corner Boxes

| Code   | Description                    | Colour    |
|--------|--------------------------------|-----------|
| SSB28W | (L) 87mm x (W) 87mm x (H) 28mm | White     |
| SSB28A | (L) 87mm x (W) 87mm x (H) 28mm | Aluminium |
| SSB28B | (L) 87mm x (W) 87mm x (H) 28mm | Black     |
| SSB28M | (L) 87mm x (W) 87mm x (H) 28mm | Magnolia  |
| SSB28O | (L) 87mm x (W) 87mm x (H) 28mm | Oak       |

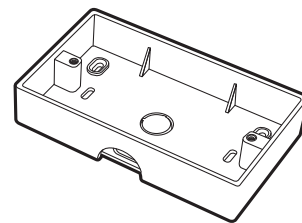

## Twin Surface Box 28mm & 35mm Depth



\* All surface boxes supplied c/w push out tabs



All D-Line twin two-gang Surface Boxes have push-out tabs, so for a single entry/exit there is no need to create knockouts!

Same as single versions, these boxes are malleable so it can be easy to make any additional entries required.

Use with Box Adaptors — or Box Adaptor Tees to connect in line between vertical and horizontal installations; 30 x 15mm and 50 x 25mm ½ round can connect to D-Line Surface Boxes using Box Adaptor Tees.

- For UK specification surface-mounted two-gang sockets
- Push-out tab to create clean and perfect knock-out
- Can accept D-Line Box Adaptor and Box Adaptor Tee accessories
- Malleable, not brittle
- Easy to drill alternative/additional entry points
- Fully safety tested and certified to BS 4662:2006+A1:2009

### 28mm Deep Standard Corner Boxes

| Code   | Description                     | Colour    |
|--------|---------------------------------|-----------|
| TSB28W | (L) 147mm x (W) 87mm x (H) 28mm | White     |
| TSB28A | (L) 147mm x (W) 87mm x (H) 28mm | Aluminium |
| TSB28B | (L) 147mm x (W) 87mm x (H) 28mm | Black     |
| TSB28M | (L) 147mm x (W) 87mm x (H) 28mm | Magnolia  |
| TSB28O | (L) 147mm x (W) 87mm x (H) 28mm | Oak       |

### 35mm Deep Standard Corner Boxes

| Code   | Description                     | Colour |
|--------|---------------------------------|--------|
| TSB35W | (L) 147mm x (W) 87mm x (H) 35mm | White  |

### Rounded Corner Boxes

| Code    | Description                     | Colour |
|---------|---------------------------------|--------|
| TSB28RW | (L) 147mm x (W) 87mm x (H) 28mm | White  |
| TSB35RW | (L) 147mm x (W) 87mm x (H) 35mm | White  |

## Pattress Adaptor

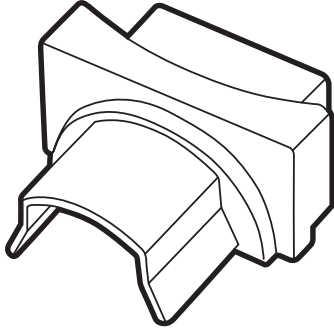

The Pattress Adaptor has internal 1/2 round shoulders which enable secure fitment under the click-lock lid of 30 x 15mm 1/2 round profiles, while the internal rectangular shoulders at opposite end can be positively retained in any 25 x 16mm knockouts.

The protruding flange is rounded to complement the circumference of popular circular pattress bases and ceiling roses.



- Connect 30 x 15mm Mini Trunking to round surface pattresses

## Circular Adaptor

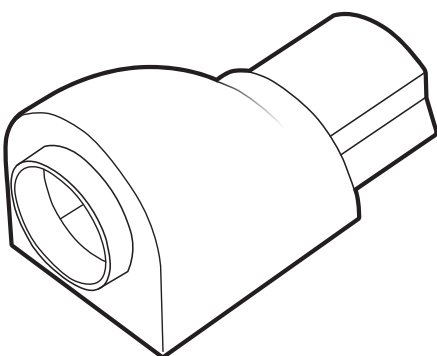

Circular Adaptors make a neat interface between 30 x 15mm Mini Trunking and flat surfaces with 20mm diameter knockouts.

Male shoulders give a secure connection inside 30 x 15mm Mini Trunking, while installers can make a 20mm diameter hole for the circular flange to sit inside. Popular for example to fit up to surface luminaires, flat-sided enclosures, and to contain 2x 1.5mm 2c FP cables dropping to break glass units.



- Connect 30 x 15mm Mini Trunking to flat surfaces with 20mm diameter knockouts



## Flat Adaptor

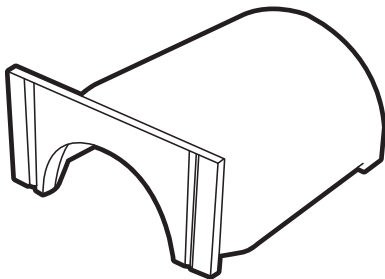

**Flat Adaptors clip over ends of 30 x 15mm Mini Trunking and have a flange cover to neatly cover cut-outs (< 30 x 15mm) on a flat edge.**

They save the need for precise notching, and enable cables to be neatly routed through a flat surface and into 30 x 15mm ½ round D-Line Mini Trunking profiles.

The flange can fit 34 x 17mm apertures, or can easily be cut to fit 25 x 16mm knock-outs.



The Flat Adaptor can interface with traditional flat-edge trunkings in cornice and coving applications; with the flat-edged accessories of popular coving trunkings; and popular flat-edged pattress bases also – for example breaking-out to D-Line 30 x 15mm across ceilings or vertical runs to switch/socket drops, where the ½ round appearance gives a smart solution with uniquely subtle aesthetics.

- Connect 30 x 15mm Mini Trunking lengths to flat-faced surfaces

## Box Adaptor

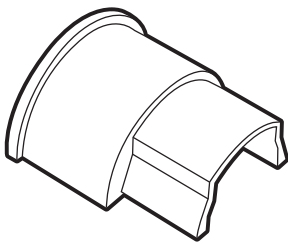

**Box Adaptors have internal shoulders which securely fit into 30 x 15mm Mini Trunking. The circular flange locks into the 30 x 15mm ½ round cut out on D-Line surface boxes.**

- For use between 30 x 15mm Mini Trunking and D-Line Surface Boxes

## Box Adaptor Tee

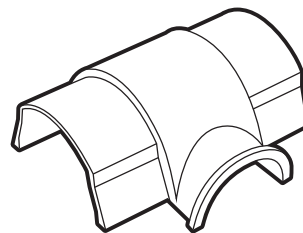

**Box Adaptor Tees connect 2 lengths of same size trunking on a straight horizontal or vertical run, and have a rounded top-flange which can lock into the pre-formed cut-out of D-Line Surface Boxes.**

- For use with D-Line Surface Boxes
- Smooth-Fit available for 30 x 15mm and round trunkings
- Clip-Over version for 50 x 25mm is also available



# Accessories Fitting Guide



## Clip-Over Accessories - for 1/2 round 20x10mm, 30x15mm, 50x25mm profiles & 22x22mm 1/4 round only

Design forgives rough or oblique cuts, and imprecise measuring.

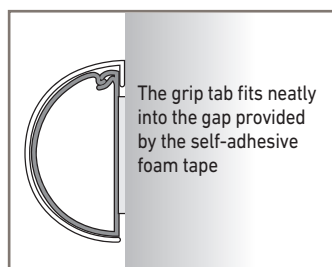
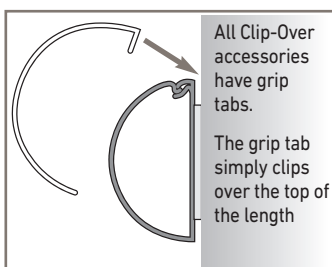

 **½ round 16 x 8mm Micro Trunking**

|                    |                          | White    | Magnolia | Aluminium Effect | Black    | Oak Effect |
|--------------------|--------------------------|----------|----------|------------------|----------|------------|
| <b>Lengths</b>     | 3m Length                | R3D1608W | R3D1608M | R3D1608A         | R3D1608B | R3D1608O   |
|                    | 2m Length                | R2D1608W | R2D1608M | R2D1608A         | R2D1608B | R2D1608O   |
| <b>Accessories</b> | Smooth-Fit Internal Bend | IB1608W  | IB1608M  | IB1608A          | IB1608B  | IB1608O    |
|                    | Smooth-Fit External Bend | EB1608W  | EB1608M  | EB1608A          | EB1608B  | EB1608O    |
|                    | Smooth-Fit Flat Bend     | FB1608W  | FB1608M  | FB1608A          | FB1608B  | FB1608O    |
|                    | Smooth-Fit Equal Tee     | NET1608W | NET1608M | NET1608A         | NET1608B | NET1608O   |
|                    | Smooth-Fit Coupler       | NCP1608W | NCP1608M | NCP1608A         | NCP1608B | NCP1608O   |
|                    | Smooth-Fit End Cap       | EC1608W  | EC1608M  | EC1608A          | EC1608B  | EC1608O    |



 **½ round 20 x 10mm Micro+ Trunking**

|                               |                         | White     |
|-------------------------------|-------------------------|-----------|
| <b>Lengths</b>                | 3m Length               | R3D2010W  |
|                               | 2m Length               | R2D2010W  |
| <b>Clip-Over Accessories</b>  | Clip-Over Internal Bend | FLIB2010W |
|                               | Clip-Over External Bend | FLEB2010W |
|                               | Clip-Over Flat Bend     | FLFB2010W |
|                               | Clip-Over Equal Tee     | FLET2010W |
| <b>Smooth-Fit Accessories</b> | Smooth-Fit Coupler      | CP2010W   |
|                               | Smooth-Fit End Cap      | EC2010W   |

 **½ round 30 x 15mm Mini Trunking**

|                               |                                   | White     | Magnolia  | Aluminium Effect | Black     | Oak Effect | Red       |
|-------------------------------|-----------------------------------|-----------|-----------|------------------|-----------|------------|-----------|
| <b>Lengths</b>                | 3m Length                         | R3D3015W  | R3D3015M  | R3D3015A         | R3D3015B  | R3D3015O   | R3D3015R  |
|                               | 2m Length                         | R2D3015W  | R2D3015M  | R2D3015A         | R2D3015B  | R2D3015O   | -         |
|                               | 3m Self Adhesive Internal Divider | 3AD3015L  | -         | -                | -         | -          | -         |
| <b>Clip-Over Accessories</b>  | Clip-Over Internal Bend           | FLIB3015W | FLIB3015M | FLIB3015A        | FLIB3015B | FLIB3015O  | FLIB3015R |
|                               | Clip-Over External Bend           | FLEB3015W | FLEB3015M | FLEB3015A        | FLEB3015B | FLEB3015O  | FLEB3015R |
|                               | Clip-Over Flat Bend               | FLFB3015W | FLFB3015M | FLFB3015A        | FLFB3015B | FLFB3015O  | FLFB3015R |
|                               | Clip-Over Door Top Bend           | FLDB3015W | FLDB3015M | FLDB3015A        | FLDB3015B | FLDB3015O  | FLDB3015R |
|                               | Clip-Over Equal Tee               | FLET3015W | FLET3015M | FLET3015A        | FLET3015B | FLET3015O  | FLET3015R |
|                               | Clip-Over Flat Adaptor            | FA3015W   | -         | -                | -         | -          | FA3015R   |
| <b>Smooth-Fit Accessories</b> | Smooth-Fit Coupler                | CP3015W   | CP3015M   | CP3015A          | CP3015B   | CP3015O    | CP3015R   |
|                               | Smooth-Fit End Cap                | EC3015W   | EC3015M   | EC3015A          | EC3015B   | EC3015O    | EC3015R   |
|                               | Smooth-Fit Pattress Adaptor       | PA3015W   | -         | -                | -         | -          | -         |
|                               | Smooth-Fit Circular Adaptor       | CA3015W   | -         | -                | -         | -          | CA3015R   |
|                               | Smooth-Fit Box Adaptor            | BA3015W   | BA3015M   | BA3015A          | BA3015B   | BA3015O    | BA3015R   |
|                               | Smooth-Fit Box Adaptor Tee        | AT3015W   | AT3015M   | AT3015A          | AT3015B   | AT3015O    | -         |



## 1/2 round 50 x 25mm Trunking

|                               |  | White     | Magnolia  | Aluminium Effect | Black     | Oak Effect |
|-------------------------------|--|-----------|-----------|------------------|-----------|------------|
| <b>Lengths</b>                | 3m Length  | R3D5025W  | R3D5025M  | R3D5025A         | R3D5025B  | R3D5025O   |
|                               | 2m Length  | R2D5025W  | R2D5025M  | R2D5025A         | R2D5025B  | R2D5025O   |
|                               | 3m Self Adhesive Internal Divider                  | 3AD5025L  | -         | -                | -         | -          |
| <b>Clip-Over Accessories</b>  | Clip-Over Internal Bend                            | FLIB5025W | FLIB5025M | FLIB5025A        | FLIB5025B | FLIB5025O  |
|                               | Clip-Over External Bend                            | FLEB5025W | FLEB5025M | FLEB5025A        | FLEB5025B | FLEB5025O  |
|                               | Clip-Over Flat Bend                                | FLFB5025W | FLFB5025M | FLFB5025A        | FLFB5025B | FLFB5025O  |
|                               | Clip-Over Equal Tee                                | FLET5025W | FLET5025M | FLET5025A        | FLET5025B | FLET5025O  |
|                               | Clip-Over Box Adaptor Tee                          | FLAT5025W | FLAT5025M | FLAT5025A        | FLAT5025B | FLAT5025O  |
|                               | Clip-Over Reducing Tee<br>2x 50x25mm > 1x 30x15mm  | FLRT5030W | FLRT5030M | FLRT5030A        | FLRT5030B | -          |
|                               | Clip-Over Skirting Tee<br>1x 50x25mm > 2 x 30x15mm | FLST5030W | FLST5030M | FLST5030A        | FLST5030B | -          |
| <b>Smooth-Fit Accessories</b> | Smooth-Fit Coupler                                 | CP5025W   | CP5025M   | CP5025A          | CP5025B   | CP5025O    |
|                               | Smooth-Fit End Cap                                 | EC5025W   | EC5025M   | EC5025A          | EC5025B   | EC5025O    |
|                               | Smooth-Fit Box Adaptor Tee                         | AT5025W   | AT5025M   | AT5025A          | AT5025B   | AT5025O    |

### Smooth-Fit Accessories also available for

40 x 20mm 1/2 Round - Details on request

60 x 30mm 1/2 Round - Details on request

30 x 30mm 1/4 Round - Details on request



## 1/4 round 22 x 22mm Trunking/Floor Trim

|                               |                                | White     | Oak Effect | Stainable |
|-------------------------------|--------------------------------|-----------|------------|-----------|
| <b>Lengths</b>                | 3m Length                      | R3D22QSW  | -          | -         |
|                               | 2m Length                      | R2D22QSW  | R2D22QSO   | R2D22QSP  |
| <b>Clip-Over Accessories</b>  | Clip-Over Internal / Flat Bend | FLIB22QSW | FLIB22QSO  | FLIB22QSP |
|                               | Clip-Over External Bend        | FLEB22QSW | FLEB22QSO  | FLEB22QSP |
|                               | Clip-Over Inlet/Outlet         | FLCO22QSW | FLCO22QSO  | FLCO22QSP |
| <b>Smooth-Fit Accessories</b> | Smooth-Fit Internal/Flat Bend  | FB22QSW   | FB22QSO    | FB22QSP   |
|                               | Smooth-Fit External Bend       | EB22QSW   | EB22QSO    | EB22QSP   |
|                               | Smooth-Fit Cable Inlet         | CI22QSW   | CI22QSO    | CI22QSP   |
|                               | Smooth-Fit Cable Outlet        | CO22QSW   | CO22QSO    | CO22QSP   |
|                               | Smooth-Fit Coupler             | CP22QSW   | CP22QSO    | CP22QSP   |
|                               | Smooth-Fit End Cap (left)      | EC22QSW/L | EC22QSO/L  | EC22QSP/L |
|                               | Smooth-Fit End Cap (right)     | EC22QSW/R | EC22QSO/R  | EC22QSP/R |

## Colours

W White

M Magnolia

A Aluminium Effect





B Black

O Oak Effect

R Red

P Premium Wood  
(stainable 22x22 only)\*

illustrations not to scale

|  | Shape & Size W x H   |  |   |   |  |
|--|--|--|---|---|--|
|  | <br>16x8mm                                  | <br>20x10mm | <br>30x15mm   | <br>50x25mm      | <br>22x22mm |
| <b>Trunking Lengths</b>                              |  |  |   |   |  |
| 3m Length  | <input type="checkbox"/> <input type="checkbox"/> <input type="checkbox"/> <input type="checkbox"/> <input type="checkbox"/> | <input type="checkbox"/>   | <input type="checkbox"/> <input type="checkbox"/> <input type="checkbox"/> <input type="checkbox"/> <input type="checkbox"/> <input type="checkbox"/> | <input type="checkbox"/> <input type="checkbox"/> <input type="checkbox"/> <input type="checkbox"/> | <input type="checkbox"/>   |
| 2m Length  | <input type="checkbox"/> <input type="checkbox"/> <input type="checkbox"/> <input type="checkbox"/>                          | <input type="checkbox"/>   | <input type="checkbox"/> <input type="checkbox"/> <input type="checkbox"/> <input type="checkbox"/>   | <input type="checkbox"/> <input type="checkbox"/> <input type="checkbox"/> <input type="checkbox"/> | <input type="checkbox"/> <input type="checkbox"/>  |
| 3m Self Adhesive Divider<br>Suitable for all colours |  |  | <input type="checkbox"/>  | <input type="checkbox"/>  |  |
| <b>Clip-Over Accessories</b>                         |  |  |   |   |  |
| Flat Bend  |  | <input type="checkbox"/>   | <input type="checkbox"/> <input type="checkbox"/> <input type="checkbox"/> <input type="checkbox"/> <input type="checkbox"/> <input type="checkbox"/> | <input type="checkbox"/> <input type="checkbox"/> <input type="checkbox"/> <input type="checkbox"/> | Use internal bend  |
| Internal Bend  |  | <input type="checkbox"/>   | <input type="checkbox"/> <input type="checkbox"/> <input type="checkbox"/> <input type="checkbox"/> <input type="checkbox"/> <input type="checkbox"/> | <input type="checkbox"/> <input type="checkbox"/> <input type="checkbox"/> <input type="checkbox"/> | <input type="checkbox"/> <input type="checkbox"/>  |
| External Bend  |  | <input type="checkbox"/>   | <input type="checkbox"/> <input type="checkbox"/> <input type="checkbox"/> <input type="checkbox"/> <input type="checkbox"/> <input type="checkbox"/> | <input type="checkbox"/> <input type="checkbox"/> <input type="checkbox"/> <input type="checkbox"/> | <input type="checkbox"/> <input type="checkbox"/>  |
| Equal Tee  |  | <input type="checkbox"/>   | <input type="checkbox"/> <input type="checkbox"/> <input type="checkbox"/> <input type="checkbox"/> <input type="checkbox"/> <input type="checkbox"/> | <input type="checkbox"/> <input type="checkbox"/> <input type="checkbox"/> <input type="checkbox"/> |  |
| Door Top Bend  |  | Use flat bend  | <input type="checkbox"/> <input type="checkbox"/> <input type="checkbox"/> <input type="checkbox"/> <input type="checkbox"/> <input type="checkbox"/> | Use flat bend   |  |
| Box Adaptor Tee (50x25 only)                         |  |  |   | <input type="checkbox"/> <input type="checkbox"/> <input type="checkbox"/> <input type="checkbox"/> |  |
| Inlet/Outlet Coupler (22x22 only)                    |  |  |   |   | <input type="checkbox"/> <input type="checkbox"/>  |
| Flat Adaptor   |  |  | <input type="checkbox"/> <input type="checkbox"/>   |   |  |
| Reducing Tee (to 30x15 only)                         |  |  | <input type="checkbox"/>  | <input type="checkbox"/> <input type="checkbox"/> <input type="checkbox"/> <input type="checkbox"/> |  |
| Skirting Tee (to 30x15 only)                         |  |  | <input type="checkbox"/>  | <input type="checkbox"/> <input type="checkbox"/> <input type="checkbox"/> <input type="checkbox"/> |  |
| <b>Smooth Fit Accessories</b>                        |  |  |   |   |  |
| Flat Bend  | <input type="checkbox"/> <input type="checkbox"/> <input type="checkbox"/> <input type="checkbox"/>                          |  | <input type="checkbox"/> <input type="checkbox"/> <input type="checkbox"/> <input type="checkbox"/> <input type="checkbox"/> <input type="checkbox"/> | <input type="checkbox"/> <input type="checkbox"/> <input type="checkbox"/> <input type="checkbox"/> | <input type="checkbox"/> <input type="checkbox"/>  |
| Internal Bend  | <input type="checkbox"/> <input type="checkbox"/> <input type="checkbox"/> <input type="checkbox"/>                          |  | <input type="checkbox"/> <input type="checkbox"/> <input type="checkbox"/> <input type="checkbox"/> <input type="checkbox"/> <input type="checkbox"/> | <input type="checkbox"/> <input type="checkbox"/> <input type="checkbox"/> <input type="checkbox"/> | Use flat bend  |
| External Bend  | <input type="checkbox"/> <input type="checkbox"/> <input type="checkbox"/> <input type="checkbox"/>                          |  | <input type="checkbox"/> <input type="checkbox"/> <input type="checkbox"/> <input type="checkbox"/> <input type="checkbox"/> <input type="checkbox"/> | <input type="checkbox"/> <input type="checkbox"/> <input type="checkbox"/> <input type="checkbox"/> | <input type="checkbox"/> <input type="checkbox"/>  |
| Equal Tee  | <input type="checkbox"/> <input type="checkbox"/> <input type="checkbox"/> <input type="checkbox"/>                          |  | <input type="checkbox"/> <input type="checkbox"/> <input type="checkbox"/> <input type="checkbox"/> <input type="checkbox"/> <input type="checkbox"/> | <input type="checkbox"/> <input type="checkbox"/> <input type="checkbox"/> <input type="checkbox"/> |  |
| Cable Outlet   | Use equal tee  |  | <input type="checkbox"/> <input type="checkbox"/> <input type="checkbox"/> <input type="checkbox"/>   |   | <input type="checkbox"/> <input type="checkbox"/>  |
| Cable Inlet  |  |  |   |   | <input type="checkbox"/> <input type="checkbox"/>  |
| Coupler  | <input type="checkbox"/> <input type="checkbox"/> <input type="checkbox"/> <input type="checkbox"/>                          | <input type="checkbox"/>   | <input type="checkbox"/> <input type="checkbox"/> <input type="checkbox"/> <input type="checkbox"/> <input type="checkbox"/> <input type="checkbox"/> | <input type="checkbox"/> <input type="checkbox"/> <input type="checkbox"/> <input type="checkbox"/> | <input type="checkbox"/> <input type="checkbox"/>  |
| End Cap  | <input type="checkbox"/> <input type="checkbox"/> <input type="checkbox"/> <input type="checkbox"/>                          | <input type="checkbox"/>   | <input type="checkbox"/> <input type="checkbox"/> <input type="checkbox"/> <input type="checkbox"/> <input type="checkbox"/> <input type="checkbox"/> | <input type="checkbox"/> <input type="checkbox"/> <input type="checkbox"/> <input type="checkbox"/> |  |
| End Cap Left (¼ round only)                          |  |  |   |   | <input type="checkbox"/> <input type="checkbox"/>  |
| End Cap Right (¼ round only)                         |  |  |   |   | <input type="checkbox"/> <input type="checkbox"/>  |
| Box Adaptor Tee                                      |  |  | <input type="checkbox"/> <input type="checkbox"/> <input type="checkbox"/> <input type="checkbox"/>   | <input type="checkbox"/> <input type="checkbox"/> <input type="checkbox"/> <input type="checkbox"/> |  |
| Patress Adaptor                                      |  |  | <input type="checkbox"/>  |   |  |
| Circular Adaptor                                     |  |  | <input type="checkbox"/> <input type="checkbox"/>   |   |  |
| <b>Safe-D Range</b>                                  |  |  |   |   |  |
| <b>Fire Rated Cable Supports</b>                     |  |  |   |   |  |
| SAFE-D U-Clip 30                                     |  |  | ✓   |   |  |
| SAFE-D U-Clip 40                                     |  |  |   | ✓   |  |
| SAFE-D U-Clip 50                                     |  |  |   |   |  |
| SAFE-D F-Clip 30                                     |  |  | ✓   |   |  |
| SAFE-D F-Clip 40                                     |  |  |   | ✓   |  |
| SAFE-D F-Clip 50                                     |  |  |   |   |  |
| SAFE-D Spring Clip                                   | ✓  | ✓  | ✓   | ✓   | ✓  |
| SAFE-D D-Fixing                                      | ✓  | ✓  | ✓   | ✓   | ✓  |
| <b>Other Accessories</b>                             |  |  |   |   |  |
| Ratchet Cutting Tool                                 | ✓  | ✓  | ✓   |   | ✓  |

| <b>Surface Boxes</b> |  |                     |   |
|----------------------|--|---------------------|---|
| 28mm Deep Single     | <input type="checkbox"/> <input type="checkbox"/> <input type="checkbox"/> <input type="checkbox"/> <input type="checkbox"/> | 35mm Deep Single    | <input type="checkbox"/> <input type="checkbox"/> |
| 28mm Deep Twin       | <input type="checkbox"/> <input type="checkbox"/> <input type="checkbox"/> <input type="checkbox"/>                          | 35mm Deep Twin      | <input type="checkbox"/>                          |
| 28mm Rounded Single  | <input type="checkbox"/>   | 35mm Rounded Single | <input type="checkbox"/>                          |
| 28mm Rounded Twin    | <input type="checkbox"/>   | 35mm Rounded Twin   | <input type="checkbox"/>                          |

## 1/2 round Clip-Over Accessories - for 20x10mm, 30x15mm and 50x25mm only



**Internal Bend**  
Join lengths around 90 degree inside corners.



**External Bend**  
Join lengths around 90 degree outside corners.

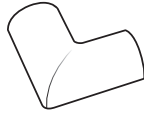

**Flat Bend**  
Change direction by 90 degrees on flat surfaces.

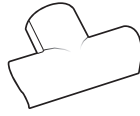

**Equal Tee**  
Use to join 3 lengths of same profile.

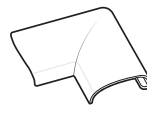

**Door Top Bend**  
Change direction by 90 degrees around frame tops.

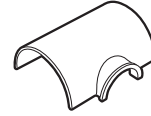

**Box Adaptor Tee**  
For use with D-Line Surface Socket Boxes. **50x25mm only**

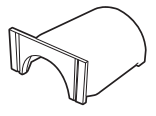

**Flat Adaptor**  
Connect Mini Trunking to flat surfaces **30x15mm only**

## 1/4 round Clip-Over Accessories - For 22x22mm only



**Internal Bend**  
Join lengths around 90 degree inside corners.



**External Bend**  
Join lengths around 90 degree outside corners.



**Cable Inlet/Outlet**  
Use to provide cable entry/exit point between 2 lengths.



Use with Smooth-Fit Couplers & End Caps

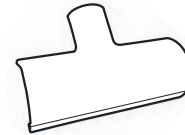

**Reducing Tee**  
Connect 2x 50x25mm lengths to 1x 30x15mm length.

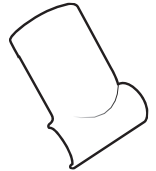

**Skirting Tee**  
Connect 1x 50x25mm length to 2 x 30x15mm lengths.

## 1/2 round Smooth-Fit Accessories

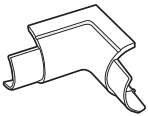

**Internal Bend**  
Join lengths around 90 degree inside corners.

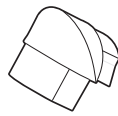

**External Bend**  
Join lengths around 90 degree outside corners.

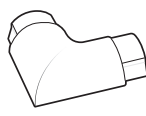

**Flat Bend**  
Change direction by 90 degrees on flat surfaces.

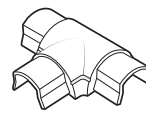

**Equal Tee**  
Use to join 3 lengths of same profile.

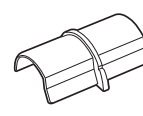

**Coupler**  
Join 2 lengths of same profile on flat surface.

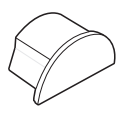

**End Cap**  
Neatly finish open ends.



**Pattress Adaptor**  
Connect Mini Trunking to round surface pattresses. **30x15mm only**

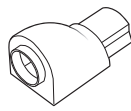

**Circular Adaptor**  
Connect Mini Trunking to flat edge surfaces with 20mm Ø knock-outs. **30x15mm only**

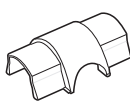

**Cable Inlet/Outlet**  
Takes cables in or out of a Mini Trunking. Use between lengths on straight runs. **30x15mm only**

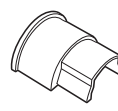

**Box Adaptor**  
For use with D-Line Surface Socket Boxes. **30x15mm only**

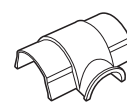

**Box Adaptor Tee**  
For use with D-Line Surface Socket Boxes. **30x15mm only**

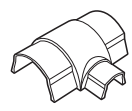

**Reducing Tee**  
Connect to 30x15mm Mini Trunking.

## 1/4 round Smooth-Fit Accessories



**Internal Bend**  
Join lengths around 90 degree inside corners.

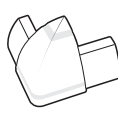

**External Bend**  
Join lengths around 90 degree outside corners.

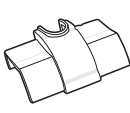

**Cable Inlet**  
Use to provide cable entry point between 2 lengths.

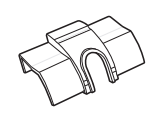

**Cable Outlet**  
Use to provide cable exit point between 2 lengths.

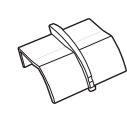

**Coupler**  
Joins 2 lengths on flat surfaces.

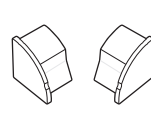

**End Cap**  
Neatly finish open ends (left & right versions apply).

## Other Accessories

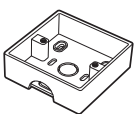

**Single Surface Socket Box**  
For use with 30x15mm and 50x25mm Trunking. Available in 28mm & 35mm depth.

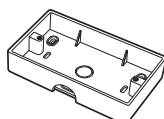

**Twin Surface Socket Box**  
For use with 30 x 15mm, and 50x25mm Trunking. Available in 28mm & 35mm depth.

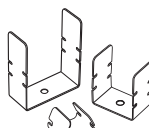

**Safe-D U-Clips**  
Fire rated U-shaped clips for use with D-Line and traditional trunkings. Safe-D Red version also available.

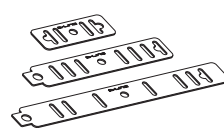

**Safe-D F-Clips**  
Fire rated flat, foldable, flexible cable clips for use with D-Line and traditional trunkings, as well as direct to surface installations.



**Safe-D Spring**  
Effectively secures single cables (<7mm o/d), either direct to surface or in PVC micro trunkings.

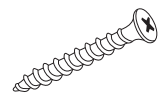

**Safe-D D-Fixing**  
Use for securing D-Line fire-rated Safe-D ranges & other equipment in popular substrates

# About the Safe-D® Range

Fully tested & certified... Clip & Comply



**Having invented the first fire-rated clips that could be fixed to substrates, or in non-metallic trunkings, D-Line acknowledge how cable management can literally be a matter of life and death in fire conditions, requiring an uncompromising approach to installations.**

We respect how specifiers need fire-tested solutions, ensuring that cables will not drop to create potentially fatal entanglements.

D-Line appreciate also that installers of surface-mounted cables need reliable fixing-systems that are easy-to-use and versatile, giving assured compliance and peace of mind to all stakeholders.

At D-Line we offer innovative ranges that uniquely satisfy regulatory and best practice requirements. Our products have been designed after extensive research and development, with technical features and installer benefits that deliver outstanding value and quality.

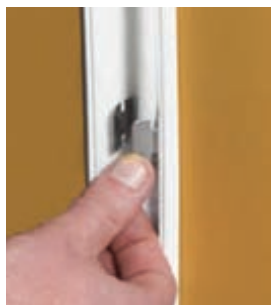

Safe-D® U-Clips



Safe-D® F-Clips

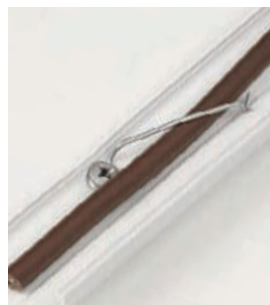

Safe-D® Spring Clip



Safe-D® Conduit Clip



Safe-D® D-Fixing



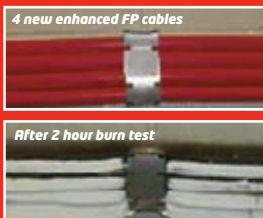

## Are all Safe-D® products fully certified as fire-rated?

To provide assurance and peace of mind, all D-Line Safe-D® products have been certified by Warringtonfire. Tests confirmed that all products can hold cables secure in temperatures of 930°C(+40 -0°C) for 2 hours and withstand required levels of shock, vibration and water spray. Copy reports on request.

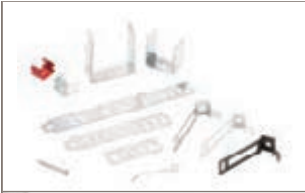
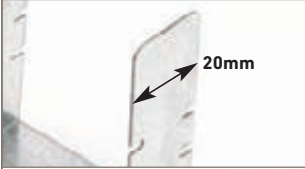

warringtonfire



|  | FEATURE                                     | BENEFIT   |
|--|---|---|
|   | <b>Alternative options</b>                  | <ul style="list-style-type: none"> <li>Alternative solutions for trunking up to 50mm width - or fix direct to surface</li> </ul>  |
|   | <b>20mm wide side-tabs</b>                  | <ul style="list-style-type: none"> <li>Thumb friendly, pliable gauge, easy to fold - quick to install</li> <li>Non-corrosive coating on all faces &amp; edges</li> <li>Cables can be added or removed</li> </ul>  |
|   | <b>Rounded corners (&amp; locking tabs)</b> | <ul style="list-style-type: none"> <li>Protects cable sheaths (and hands!)</li> <li>User friendly</li> <li>Satisfying design code BS7671 s522.8.11</li> <li>F-Clips (40mm &amp; 50mm versions) can be locked</li> </ul>   |
|   | <b>Tested &amp; Certified</b>               | <ul style="list-style-type: none"> <li>Peace of mind</li> <li>Assured performance</li> <li>Produced from traceable steel (no alloys)</li> </ul>   |
|  | <b>Multi-purpose, fire-rated fixing</b>     | <ul style="list-style-type: none"> <li>No wall plugs required</li> <li>Use to fasten Safe-D Range fixings in trunking or directly to plasterboard, drywall, wood, concrete, sandstone, limestone or brickwork</li> <li>Exceptional pull-out &amp; load-bearing performance</li> </ul> |

**Safe-D U-Clips - 1st fix clips, then 2nd fix cables!**



**Safe-D F-Clips - Uniquely versatile for shaping as required...**

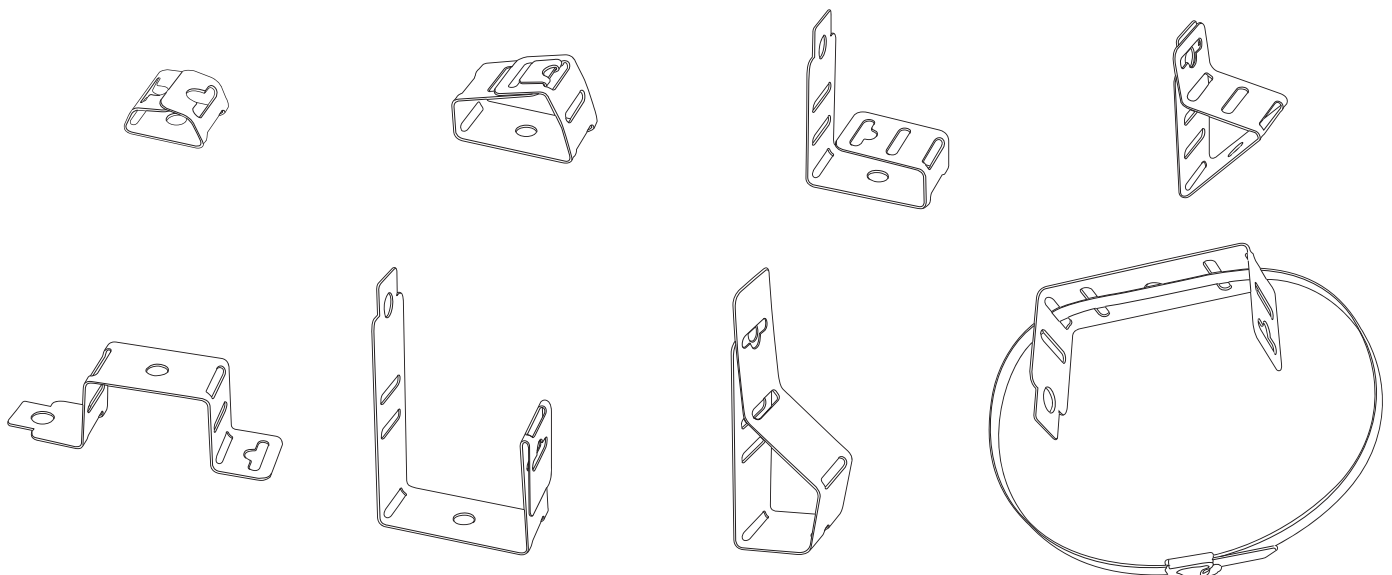



## Safe-D U-Clip 30 For 25mm+ Trunkings

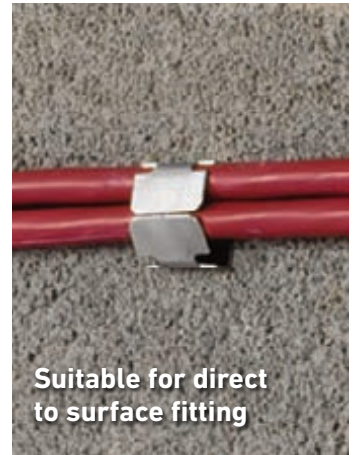
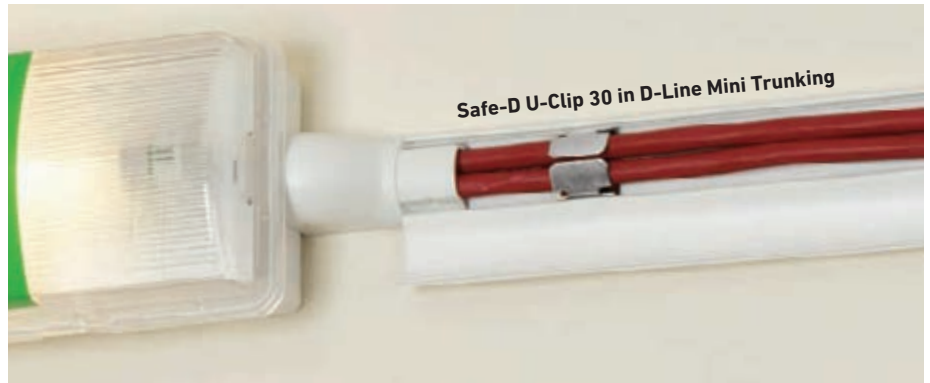

**Safe-D U-Clip 30 fits perfectly in 30 x 15mm D-Line Mini Trunking, while the 23mm base can be squeezed to fit 25 x 16mm traditional trunking also.**

Alternatively Safe-D U-Clip 30's can be fixed directly to surfaces, with user-friendly and pliable tabs that simply fold inwards to secure cables.

**1st fix clips, then 2nd fix cables!**

- Certified for 2 hours at 970°C
- Compliant with BS7671 and BS5839-1 requirements
- Thumb friendly, easy fold side-tabs
- Non-corrosive coating
- Ideal for ceiling voids, or popular PVC trunking
- Rounded edges for easy handling

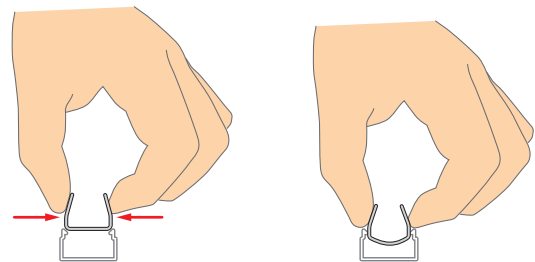
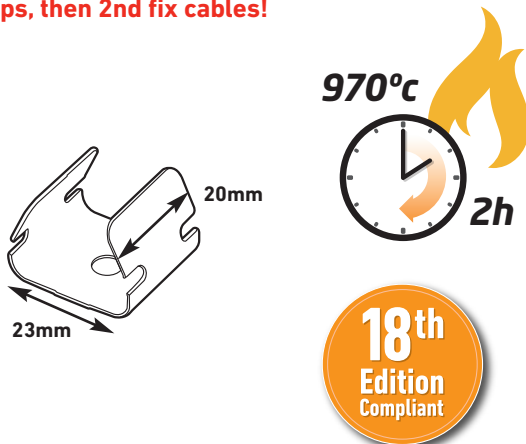

When inserting U-Clip 30 in 25x16mm trunkings, gently squeezing the upright tabs causes the base to compress for tight fitment in Size 2 trunkings.

| Code     | Description  |
|----------|--|
| SAFE-D30 | (L) 20mm x (W) 23mm x (H) 8mm (folded) 5.7mm diameter pre-drilled hole in base |



## Safe-D Red U-Clip 30

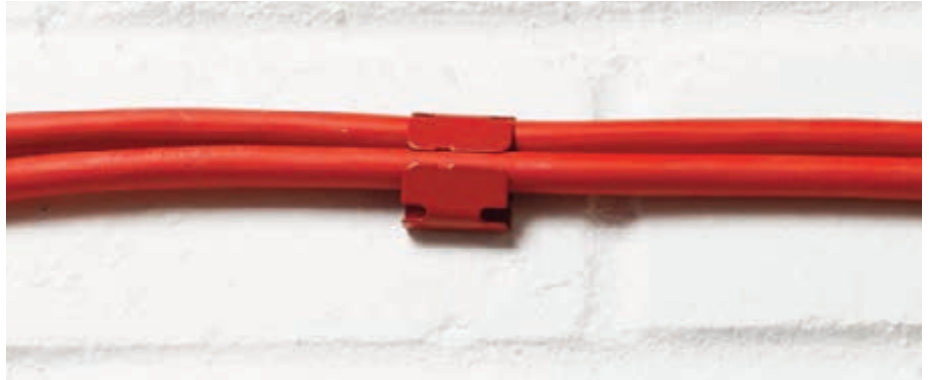

**Safe-D Red U-Clip 30 can be fitted directly to surfaces, with tabs that simply fold-over to secure cables.**

The red finish makes a popular solution for containing red-sheathed fire performance cables direct to surface.

The 23mm width is ideal for popular 2x MICC or FP-cable combinations.

**1st fix clips, then 2nd fix cables!**

- Certified for 2 hours at 970°C
- Compliant with BS7671 and BS5839-1 requirements
- Thumb friendly, easy fold side-tabs
- Non-corrosive coating
- Ideal for fixing direct to surface
- Rounded edges for easy handling

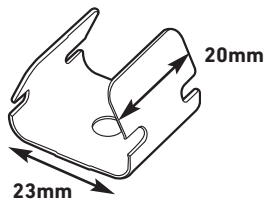

| Code         | Description  |
|--------------|--|
| SAFE-D30/RED | (L) 20mm x (W) 23mm x (H) 8mm (folded) 5.7mm diameter pre-drilled hole in base |

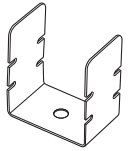

## Safe-D U-Clip 40 For 38mm+ Trunkings

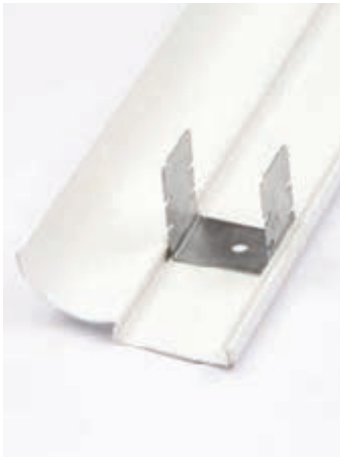

Suitable for direct to surface fitting

**Safe-D U-Clip 40 is ideal for fitment in 38mm or 40mm non-metallic trunking bases, or to provide a first-fix solution for securing cables direct to surfaces.**

Installers should use a fire-rated fixing, such as D-Line D-Fixings (see page 38), and then simply fold-over tabs to secure cables.

**1st fix clips, then 2nd fix cables!**

- Certified for 2 hours at 970°C
- Compliant with BS7671 and BS5839-1 requirements
- Thumb friendly, easy fold side-tabs
- Non-corrosive coating
- Ideal for ceiling voids, or popular PVC trunking
- Rounded edges for easy handling

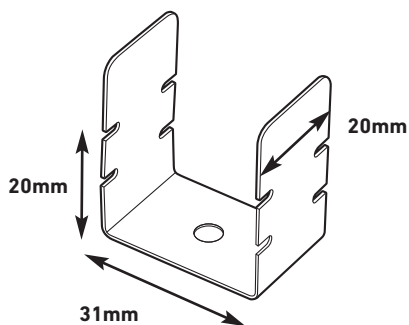

| Code     | Description  |
|----------|--|
| SAFE-D40 | (L) 20mm x (W) 31mm x (H) 20mm (folded - max height) 5.7mm diameter pre-drilled hole in base |

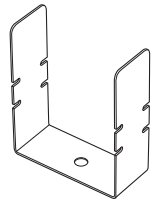

## Safe-D U-Clip 50 For 50mm+ Trunkings



**Safe-D U-Clip 50 Clips are popular for fitment in 50mm non-metallic trunking bases, or to provide a first-fix solution for securing cables direct to surfaces.**

Installers should use a fire-rated fixing, such as D-Line D-Fixings (see page 38), and then simply fold-over tabs to secure cables.

**1st fix clips, then 2nd fix cables!**

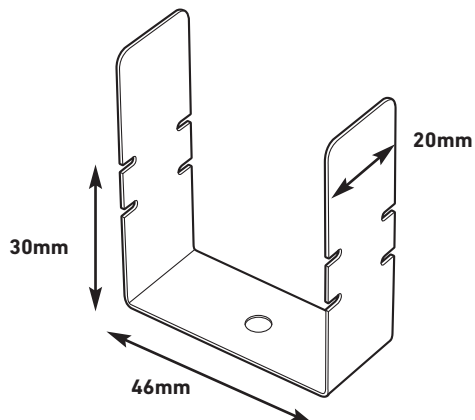

- Certified for 2 hours at 970°C
- Compliant with BS7671 and BS5839-1 requirements
- Thumb friendly, easy fold side-tabs
- Non-corrosive coating
- Ideal for ceiling voids, or popular PVC trunking
- Rounded edges for easy handling



**Code**

**Description**

**SAFE-D50**

**(L) 20mm x (W) 46mm x (H) 30mm (folded - max height) 5.7mm diameter pre-drilled hole in base**



## Safe-D F-Clip 30 Flex, Fit, Fold

970°C



2h

18<sup>th</sup>  
Edition  
Compliant



Space efficient, pocket friendly & easy to handle

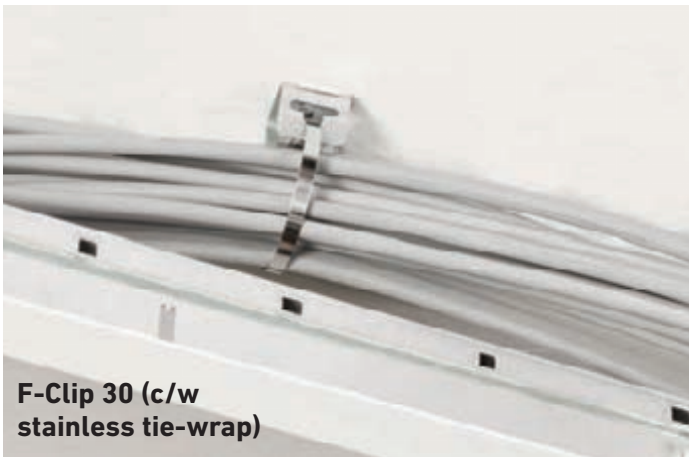

F-Clip 30 (c/w stainless tie-wrap)



Suitable for direct to surface fitting

**Safe-D F-Clip 30 is a fire-rated flexible cable clip that is supplied in flat form, and can be quickly folded to secure cable installations.**

Users simply fold upright those notches which are either side of the 5.7mm fixing hole; to make a U-shape for use in 25x16mm mini trunking, or D-Line 30x15mm mini trunking.

The flat-form is also ideal for shot-fired fixings which can be first-fixed, before sides are inwardly folded to secure cables.

Side notches can also be used to thread steel ties, useful for securing larger bundles of cables.

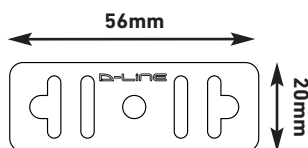

- Supplied flat...
  - Space efficient and pocket friendly
  - Easier handling - to save installation time
  - Easy folding to consider space and cable volume
  - Perfect for shot fired fixings
- Compliant with BS7671 and BS5839-1 requirements
- >1200°C melting point
- Slots enable use as cable tie base
- 3x fixing holes for versatility, ideal for use with D-Line D-Fixings
- Thumb friendly, rounded corners, 20mm wide, and pliable for easy installation
- Fit direct to surface, or in PVC trunkings
- Easy to later add or remove cable(s)
- Uniquely versatile - for shaping as required

| Code         | Description   |
|--------------|---|
| SAFEDFLCIP30 | (L) 56mm x (W) 20mm x (H) 8mm (folded - max height) 5.7mm diameter pre-drilled hole in base |

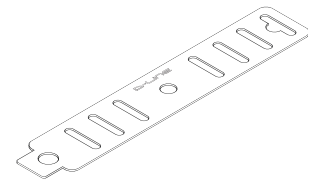

## Safe-D F-Clip 40 Flex, Fit, Fold & Lock

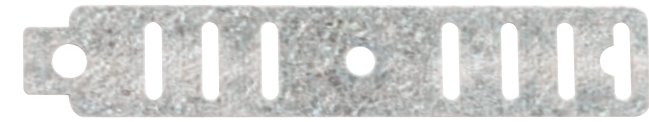

F-Clip 40 as top hat style



970°C



2h



Space efficient, pocket friendly & easy to handle



F-Clip 40 c/w SWA cables

**Safe-D F-Clip 40 is a fire-rated flexible cable clip that is supplied in flat form, and can be folded to make a variety of shapes to most effectively secure cable installations.**

Installers can pass the locking tab through a choice of opposing slots, according to the volume of cables to be secured.

The locking tab gives greatest security, and can be return-folded if preferred.

Safe-D F-Clip notches can be flexed (for example to open for adding or removing cables) up to five times, after which replacement F-Clips should be used.

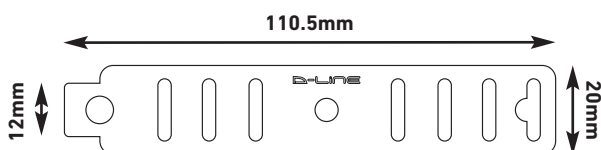

- Supplied flat...
  - Space efficient and pocket friendly
  - Easier handling - to save installation time
  - Easy folding to consider space and cable volume
  - Perfect for shot fired fixings
- Compliant with BS7671 and BS5839-1 requirements
- >1200°C melting point
- Locking feature to hold cables most securely... simply push the tab through the preferred notch
- Locking tabs can be return-folded for extra security
- 3x fixing holes for versatility, ideal for use with D-Line D-Fixings
- Thumb friendly, rounded corners, 20mm wide, and pliable for easy installation
- Fit direct to surface, or in PVC trunkings
- Easy to later add or remove cable(s) - Can be opened/closed up to 5x

| Code         | Description   |
|--------------|---|
| SAFEDFCLIP40 | (L) 110.5mm x (W) 20mm x (H) 20mm (folded - max height) 5.7mm diameter pre-drilled hole in base |

## Safe-D F-Clip 50 Flex, Fit, Fold & Lock

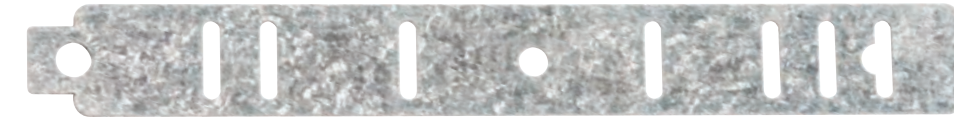
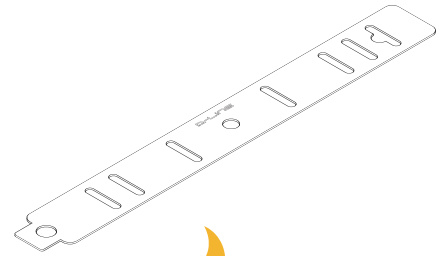

**Safe-D F-Clip 50 is a fire-rated flexible cable clip that is supplied in flat form, and can be folded to make a variety of shapes to most effectively secure cable installations.**

The first notches (either side of the 5.7mm hole) can be simply folded upward to make vertical tabs; with the base being perfect for use in 50mm width non-metallic trunking. The locking tab can then be passed through any opposing slot, according to the volume of cables to be secured.

Being 165mm long, this F-Clip is most versatile, and can be easily shaped however required, while users appreciate the pocket-friendly design saves handling and fitting time. In fire-conditions F-Clips can withstand 970°C for at least 2 hours, assuring that cable installations will not collapse. F-Clips have been extensively fire-tested on both wall planes and underside ceilings.

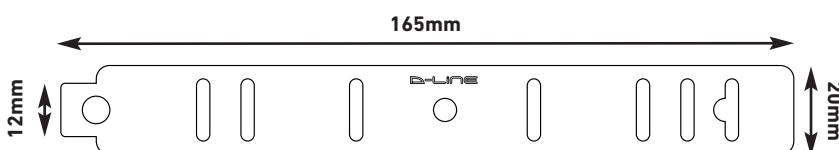

- Supplied flat...
  - Space efficient and pocket friendly
  - Easier handling - to save installation time
  - Easy folding to consider space and cable volume
  - Perfect for shot fired fixings
- Compliant with BS7671 and BS5839-1 requirements
- >1200°C melting point
- Non-corrosive finish
- Locking feature to hold cables most securely... simply push the tab through the preferred notch
- Locking tabs can be return-folded for a more secure installation
- 3x fixing holes for versatility, ideal for use with D-Line D-Fixings
- Fit direct to surface, or in PVC trunkings
- Easy to later add or remove cable(s)
  - Can be opened/closed up to 5x

| Code         | Description   |
|--------------|---|
| SAFEDFCLIP50 | (L) 165mm x (W) 20mm x (H) 35mm (folded - max height) 5.7mm diameter pre-drilled hole in base |



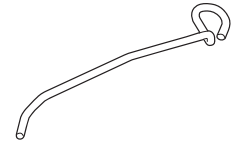

## Safe-D Spring Clip

- The spring-tensioned arm drops over to secure cables
- Adjustable according to volume of cables

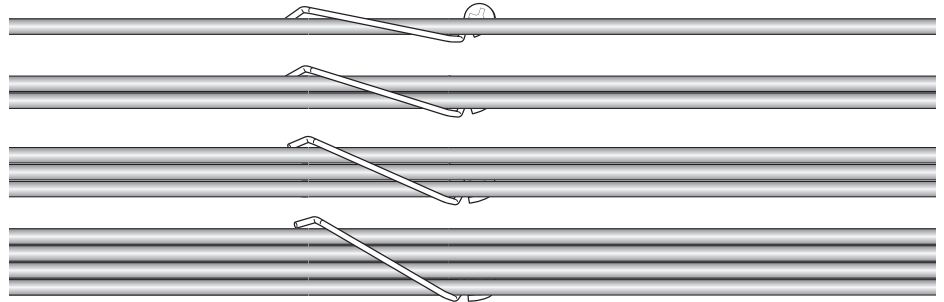

Ideal for direct-to-surface, or can fit micro trunking lengths 10mm - 20mm wide

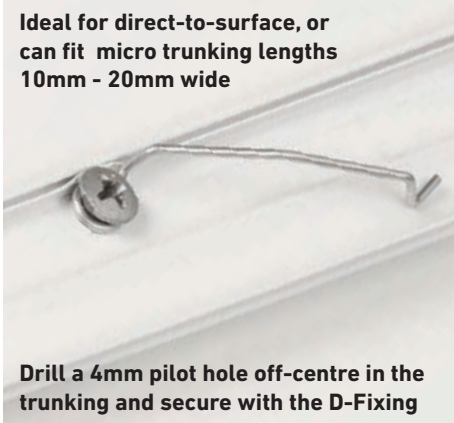

Drill a 4mm pilot hole off-centre in the trunking and secure with the D-Fixing

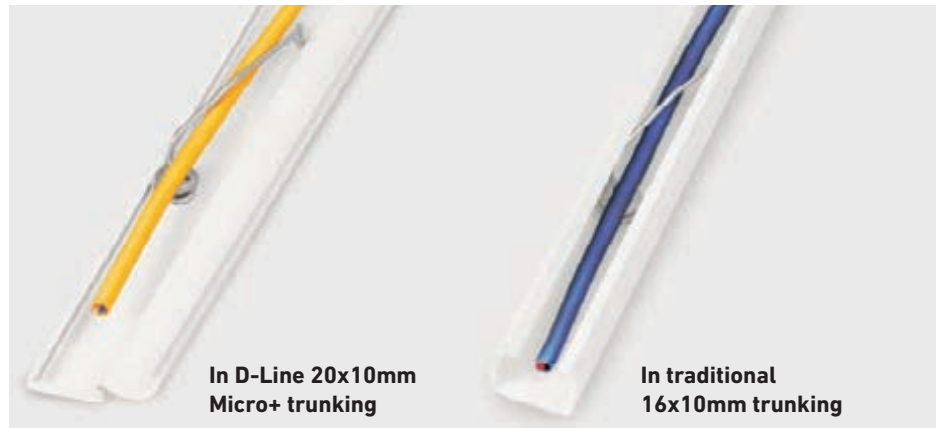

In D-Line 20x10mm Micro+ trunking

In traditional 16x10mm trunking

**Safe-D Spring Clips effectively secure single cables (<7mm o/d), either direct to surface, or in PVC micro trunkings.**

Safe-D Springs use high-temperature non-corrosive sprung steel that is tensioned to provide a strong contact with trunking bases.

In fire conditions, the Springs (when secured with D-Fixings) can hold cables in-situ at 970°C for up to 2 hours. They satisfy all requirements of BS5839 Part 1.

The 50mm long arm is specially kinked to minimise risk of cable bruising or damage to the conductors of soft-skin cables.

- Compliant with BS7671 and BS5839-1 requirements
- Sprung tensioned steel
- >1200°C melting point
- Non-corrosive finish
- Fixing hole is ideal for use with D-Line D-Fixings
- Heightened kink along length minimises risk of cable bruising
- Can be positioned at alternative angles according to application or volume of cables to be secured
- Easy to add or remove cables

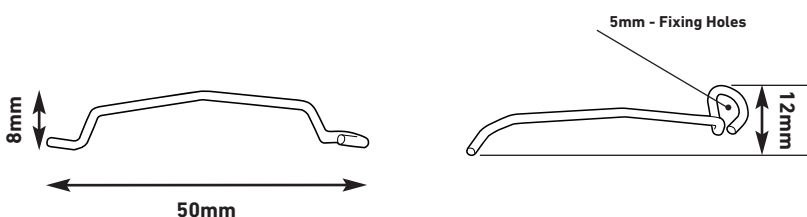
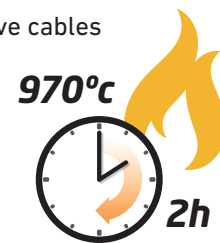

| Code        | Description  |
|-------------|--|
| SAFEDSPRING | (L) 50mm x (W) 12mm x (H) 8mm 5mm diameter fixing hole |

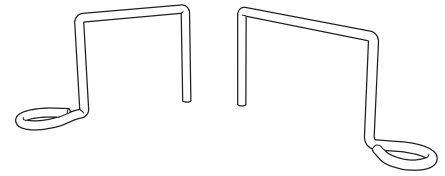

## Safe-D Retro Clips



**Retro Clips are shaped to fit outside of existing non-metallic trunking installations. They provide an easy-fit solution for trunkings that do not have internal fire-rated supports.**

Users simply position the Retro Clip over the outside faces of the trunking, then screw-fix through the 5mm eyelet to secure the clip in place; providing a discrete and subtle solution.

Retro Clips have been tested to confirm that in event of fire, after trunking has disintegrated in excessive heat, any surviving cables will be held secure.

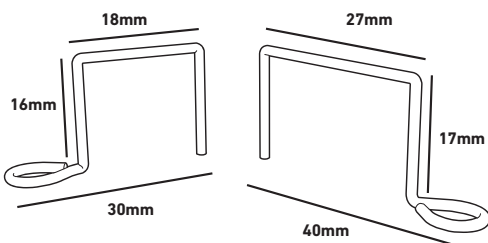

- 4 options available
- Will not drop to cause potentially fatal cable entanglements
- Simply fit 1x screw via 5mm eyelet
- Labour saving - 1 fixing only
- >1200°C melting point

| Code      | Description  |
|-----------|--|
| SD-RETRO1 | (L) 30mm x (W) 18mm x (H) 16mm For Size 1 Trunkings              |
| SD-RETRO2 | (L) 40mm x (W) 27mm x (H) 17mm For Size 2 Trunkings              |
| SD-RETRO3 | (L) 57mm x (W) 40mm x (H) 25mm For Size 3 Trunkings - <b>NEW</b> |
| SD-RETRO4 | (L) 65mm x (W) 50mm x (H) 50mm For Size 4 Trunkings - <b>NEW</b> |

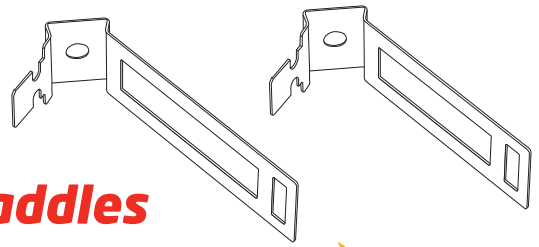

## Safe-D 20mm + 25mm Conduit Saddles



Provides a 3mm stand off from the surface



Simply wrap around the conduit, perfect for tight spaces



Secure conduit with locking tab



Centralised base fixing, gives a neat appearance to installation

**Safe-D Conduit Saddles combine fire performance, quickest fix, and a modern look, to secure cables in 20mm & 25mm outer diameter PVC and galvanised conduit installations... & 20mm or 25mm o/d cables and pipes.**

Compared to traditional saddles, where lids must be secured to bases, there is no separate lid - the conduit (and cables) is held by the wrap-design, which has an end tab that simply fits through the opposing slot to enable a secure lock.

The tight wrap, that eliminates need for wide-bases, is ideal also for installations in tight spaces.

**1 piece for only 1 fixing!**

- Compliant with BS7671 and BS5839-1 requirements
- >1200°C melting point
- Non-corrosive finish
- Unique single piece fixing, only 1x screw required
- Fixing hole is ideal for use with D-Line D-Fixings
- Available in white, black or galvanised finish
- Adjustable slot in base for fixings

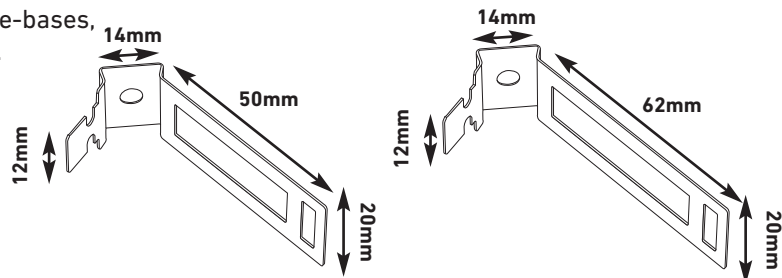

| Code          | Description   |
|---------------|---|
| SAFE-DCOND20  | (L) 86.19mm x (W) 20mm x (H) 23mm (folded - max height) |
| SAFE-DCOND20W | (L) 86.19mm x (W) 20mm x (H) 23mm (folded - max height) |
| SAFE-DCOND20B | (L) 86.19mm x (W) 20mm x (H) 23mm (folded - max height) |
| SAFE-DCOND25  | (L) 100mm x (W) 20mm x (H) 28mm (folded - max height)   |
| SAFE-DCOND25W | (L) 100mm x (W) 20mm x (H) 28mm (folded - max height)   |
| SAFE-DCOND25B | (L) 100mm x (W) 20mm x (H) 28mm (folded - max height)   |

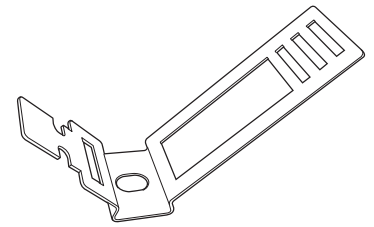

## Safe-D Adjustable XLPE/SWA Cable Clips

For 10-15mm cables

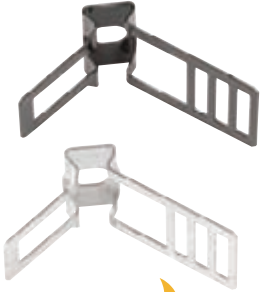

For 16-21mm cables

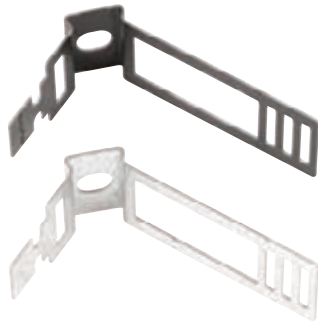

For 22-26mm cables

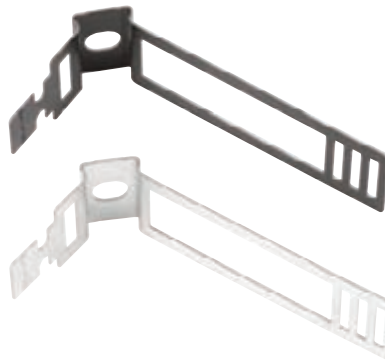

970°C



18<sup>th</sup>  
Edition  
Compliant



Provides a 3mm stand off from the surface



Simply wrap around the cable, perfect for tight spaces



Secure cable with locking tab



Centralised base fixing, gives a neat appearance to installation

**For direct-to-surface applications, Safe-D Cable Clips secure cables having diameters ranging between 10mm and 26mm.**

The one-piece, labour-saving and stylish design requires only one screw-fixing through base, before the cable is placed in the saddle. The arm can then be simply rolled over the cable, with the end tab passing via a choice of slots... then folded to lock.

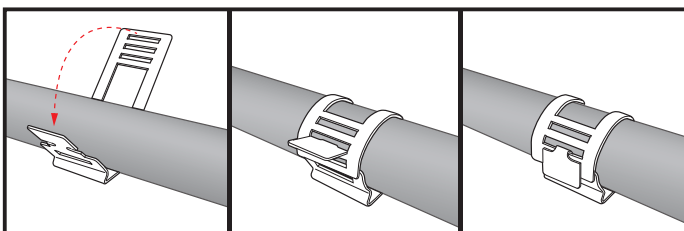

- Select the most appropriate slot, then fold-down the tab to achieve a tight fitment around the cable
- Oval shape of base hole enables the Safe-D Cable Clip to be adjusted left or right-side
- 3mm stand-off above base
- Type 1 for cables (or pipes) between 10-15mm diameters
- Type 2 for cables (or pipes) between 16-21mm diameters
- Type 3 for cables (or pipes) between 22-26mm diameters
- >1200°C melting point

| Code      | Description                      |
|-----------|----------------------------------|
| SD-CAB10  | (L) 75mm x (W) 20mm x (H) Galv   |
| SD-CAB10B | (L) 75mm x (W) 20mm x (H) Black  |
| SD-CAB16  | (L) 89mm x (W) 20mm x (H) Galv   |
| SD-CAB16B | (L) 89mm x (W) 20mm x (H) Black  |
| SD-CAB22  | (L) 104mm x (W) 20mm x (H) Galv  |
| SD-CAB22B | (L) 104mm x (W) 20mm x (H) Black |

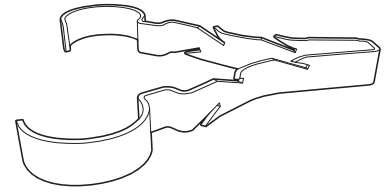

## Safe-D Stag Clips



For 1x cable options  
6-8mm & 8-10mm

For 2x cables options  
6-8mm & 8-10mm



Drill pilot hole & select appropriate size of Stag Clip



Rest Stag Clip in the pilot hole ready to accept cable(s)



Insert cable(s) before squeezing the smooth head

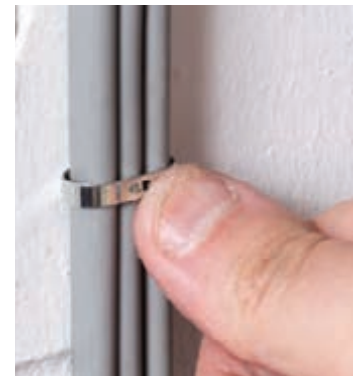

Push home to secure the Stag Clip and cable(s)

**Safe-D Stag Clips can be first-fixed with their lower barbs gripping in pilot-holes, ready for second-fix cabling works.**

After cable(s) are inserted in the head section, installers simply push home the smooth head to give a tight fitment around either one or two cables.

The Stag Clip design eliminates any need to ever handle the sharp barbs, while inserting cables is incredibly simple, and no screws are required.

- >1200°C melting point
- Can be 1st fix rested in pilot hole, before 2nd fix inserting cable(s)
- No screw required, simply push smooth head in pilot hole, 5.5mm or 6mm x 30mm deep\*
- Head sections overlap for secure cable fitment. 2x cable versions lock together when overlapped
- Ideal for FP & MICC cables, T&E and flexes

| Code                | Description                  |
|---------------------|------------------------------|
| <b>SAFEDSTAG6S</b>  | Holds 1x 6-8mm Cable. Galv   |
| <b>SAFEDSTAG6SR</b> | Holds 1x 6-8mm Cable. Red    |
| <b>SAFEDSTAG6SB</b> | Holds 1x 6-8mm Cable. Black  |
| <b>SAFEDSTAG6T</b>  | Holds 2x 6-8mm Cable. Galv   |
| <b>SAFEDSTAG6TR</b> | Holds 2x 6-8mm Cable. Red    |
| <b>SAFEDSTAG6TB</b> | Holds 2x 6-8mm Cable. Black  |
| <b>SAFEDSTAG8S</b>  | Holds 1x 8-10mm Cable. Galv  |
| <b>SAFEDSTAG8SR</b> | Holds 1x 8-10mm Cable. Red   |
| <b>SAFEDSTAG8SB</b> | Holds 1x 8-10mm Cable. Black |
| <b>SAFEDSTAG8T</b>  | Holds 2x 8-10mm Cable. Galv  |
| <b>SAFEDSTAG8TR</b> | Holds 2x 8-10mm Cable. Red   |
| <b>SAFEDSTAG8TB</b> | Holds 2x 8-10mm Cable. Black |

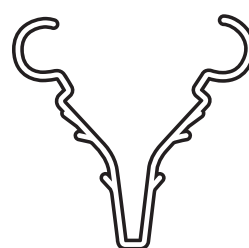

Stag Clip Single

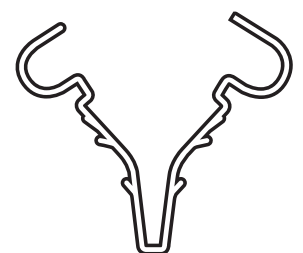

Stag Clip Twin

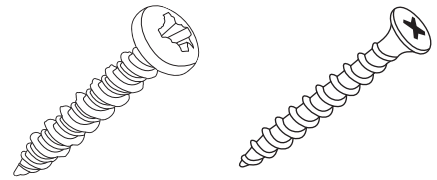

## D-Fixings



D-Fixing in Safe-D U-Clip 40



D-Fixing in Safe-D F-Clip 50



2x D-Fixings in Safe-D F-Clip 40



Conduit Clip 20 with D-Fixing



Spring Clip with D-Fixing

D-Fixings are fire-rated, with close threads for high performance. D-Fixings are ideal for securing D-Line Safe-D ranges, and other electrical installation equipment. D-Fixings can be used in masonry, plasterboard / breeze-block, concrete, brickwork and wood.

D-Fixings have been extensively tested, and are certified to hold Safe-D Clips and cable loads up to 970°C for 2 hours, after withstanding stress vibrations and water sprays also.

In fire tests the D-Fixing screw threads remain securely embedded with no need for anchors or plastic wall plugs (which typically melt at 160°C).

- Compliant with BS7671 and BS5839-1 requirements
- >1200°C melting point
- Non-corrosive finish
- No need for plastic wall plugs
- Excellent tensile strength, shear strength and pull-out load performance

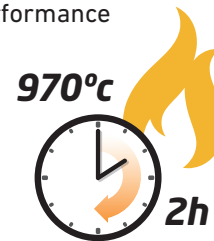

### Countersunk - 4mm pilot hole

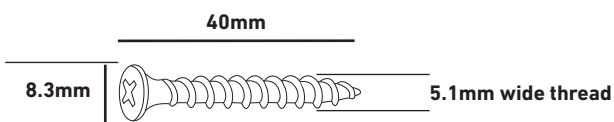

### Pan head - 5mm pilot hole

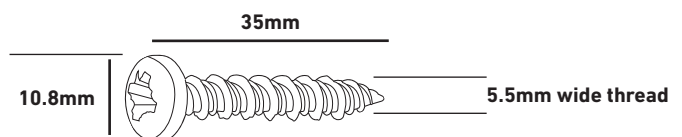

| Code   | Description   |
|--------|---|
| DFIX   | (L) 40mm x (W1) 8.3mm head width x (W2) 5.1mm thread width  |
| DFIX-P | (L) 35mm x (W1) 10.8mm head width x (W2) 5.5mm thread width |



# About D-Line Cable Safety Products



**In recent years it is a fact that personal work spaces and living spaces have both reduced, while at the same time the volume of cables around us, and often under our feet, has increased. The impact of both trends make cable management a critical issue, which requires a pro-active and responsible approach.**

When left unchecked, cables can make accidents waiting to happen. They create one of the most common causes of trips and falls, giving rise to often significant compensation awards from cable accidents which sometimes have devastating consequences.

Damaged cables and overloaded socket blocks can create electrical shocks and pose a serious fire risk.

Approximately 3,000 electrical fires occur annually in UK from cables, socket extensions and plugs.

Socket blocks and associated cable clutter can also be impossible to clean around, creating breeding grounds for allergens, an appearance of inefficiency, and a frequent cause of disconnections – and lost productivity, as feet become entangled in cables under desks.

Accidents, injuries and lost productivity from cable hazards are however almost entirely preventable - by using innovative cable safety products which can fit simply around trailing cables and socket blocks.





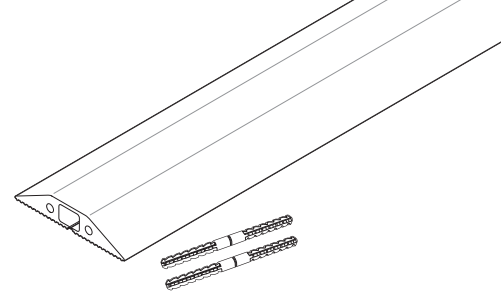

## Medium Duty Floor Cable Protector

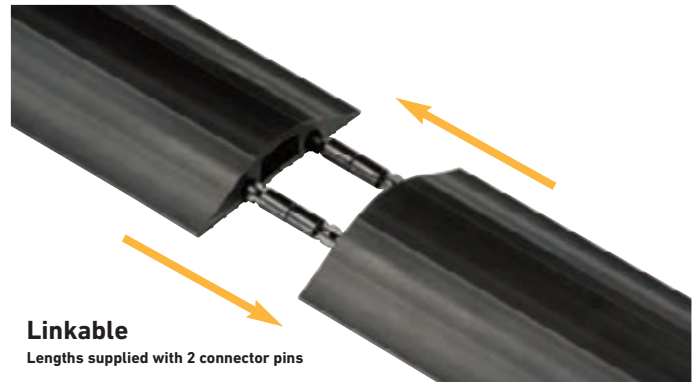

**The heavier gauge design of Medium Duty Floor Cable Protectors addresses cable trip hazards... while providing effective protection for cables.**

By minimising the risk of split insulation and damaged conductor strands, the danger of electrocution and hot spots (that create fire risks) is minimised also.

Lengths are available as 1.8m or 9m options, and supplied with friction-fit connector pins so that they can be joined to make continuous runs when necessary.

- Ideal for areas with regular foot traffic
- Protect cables, and address a common cause of trips and falls
- 14mm x 9mm cavity
- Ribbed non-slip base, pre-split rear for ease of use
- Flexible PVC - Neat tapered design, lengths uncoil to lay flat
- Fully safety tested and certified to BS EN 60670-1:2005

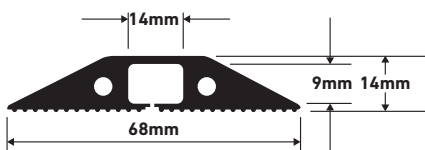

| Code     | Description   |
|----------|---|
| FC68B    | (L) 1.8m x (W) 68mm x (H) 14mm Inner channel - (W) 14mm x (H) 9mm |
| FC68B/9M | (L) 9.0m x (W) 68mm x (H) 14mm Inner channel - (W) 14mm x (H) 9mm |

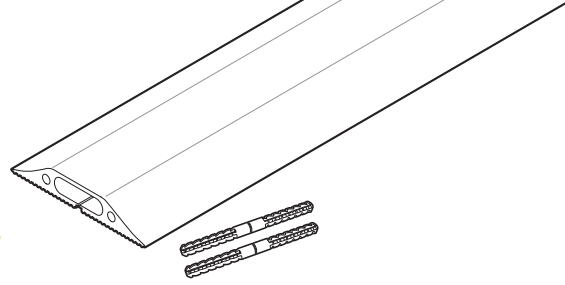

## Medium Duty Floor Cable Protector

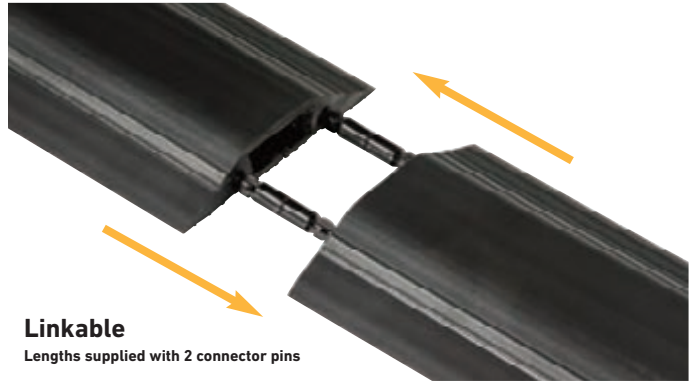

Medium Duty profiles uncoil to effectively lay flat across surfaces, while the tapered sloping sides are pedestrian-friendly.

The pre-split back enables users to simply retro-fit the profile over the cables. Features combine so that cables can be contained within the cavity, with minimal risk of movement.

The unique connector pins provide an effective friction-fit connection that can be pushed-in, then later pulled apart, in adjoining lengths – to cover whatever length of cable is required.

- Ideal for areas with regular foot traffic
- Protect cables, and address a common cause of trips and falls
- 30mm x 10mm cavity
- Ribbed non-slip base, pre-split rear for ease of use
- Flexible PVC - Neat tapered design, lengths uncoil to lay flat
- Fully safety tested and certified to BS EN 60670-1:2005

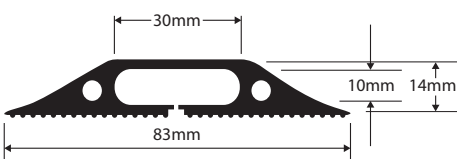

| Code     | Description  |
|----------|--|
| FC83B    | (L) 1.8m x (W) 83mm x (H) 14mm Inner channel - (W) 30mm x (H) 10mm |
| FC83B/9M | (L) 9.0m x (W) 83mm x (H) 14mm Inner channel - (W) 30mm x (H) 10mm |

# Medium Duty Floor Cable Protector with Hazard Stripe

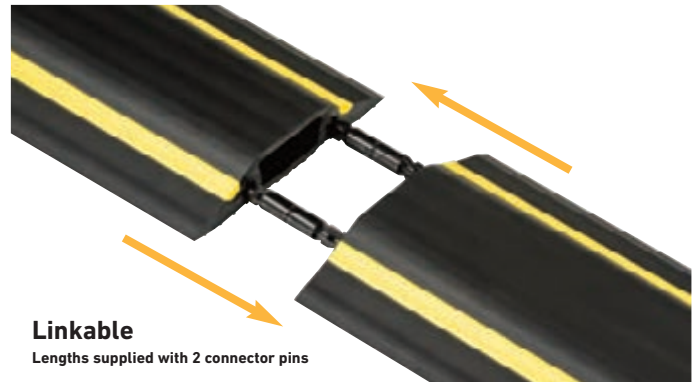
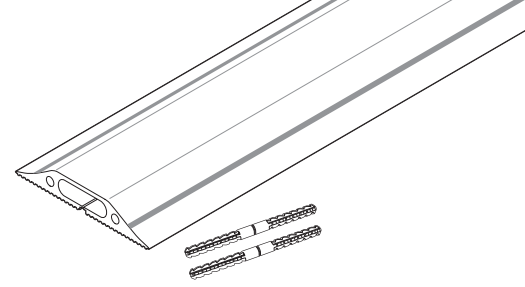

**Ideal for up to 3x 8mm diameter cables, this versatile Cable Protector is supplied with connector pins so it can be cut to shorten, then reconnected or combined with other lengths to make longer runs.**

The hazard stripe gives greater visibility to pedestrians.

Available in 1.8m lengths, or 9m length options.

Supplied with connector pins, so lengths can be joined to make longer runs.

- Ideal for areas with regular foot traffic
- Protect cables, and address a common cause of trips and falls
- Prevent cable insulation damage/electrocution and risk of broken conductor strands
- 30mm x 10mm cavity
- Ribbed non-slip base, pre-split rear for ease of use
- Flexible PVC - Neat tapered design, lengths uncoil to lay flat
- No sharp kerb-effect, pedestrian friendly
- Fully safety tested and certified to BS EN 60670-1:2005

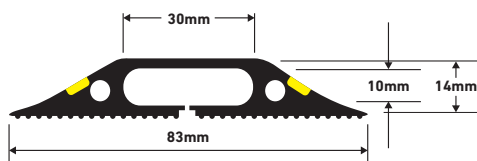

| Code     | Description  |
|----------|--|
| FC83H    | (L) 1.8m x (H) 83mm x (H) 14mm Inner channel - (W) 30mm x (H) 10mm |
| FC83H/9M | (L) 9.0m x (H) 83mm x (H) 14mm Inner channel - (W) 30mm x (H) 10mm |

# Medium Duty Floor Cable Protector 2 Compartment

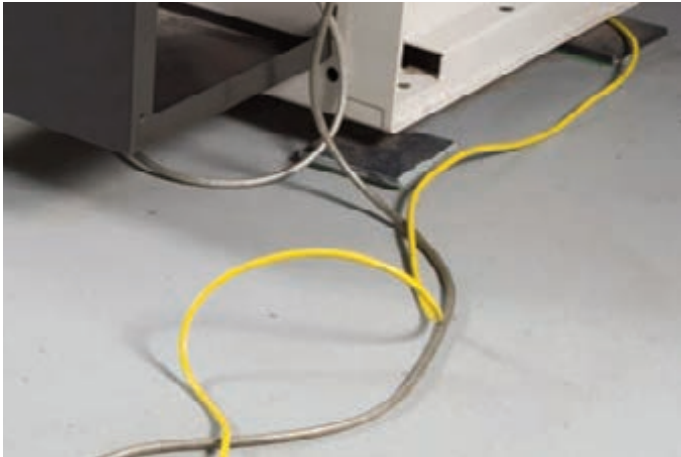
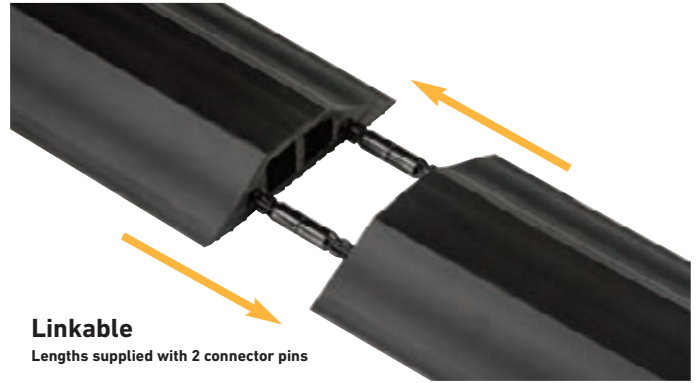
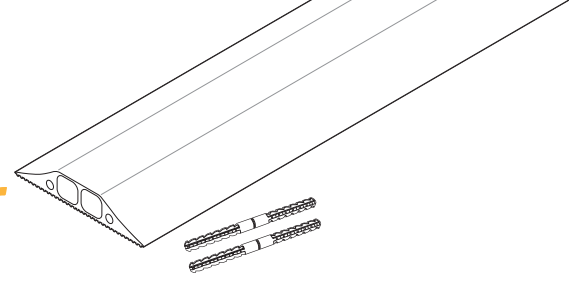

**Medium Duty 2-compartment Floor Cable Protectors are ideal if segregation is required between cable types; for example to separate mains voltage and low-voltage cables.**

Same as all D-Line Medium Duty Cable Protectors, the rear is ribbed to minimise movement on smooth surfaces.

Both cavities offer 12 x 13mm inner capacity.

Supplied with connector pins, so lengths can be joined to make longer runs.

- Ideal for areas with regular foot traffic
- Protect cables, and address a common cause of trips and falls
- Prevent cable insulation damage/electrocution and risk of broken conductor strands
- 2 x 13mm x 12mm cavity
- Ribbed non-slip base
- Flexible PVC - Neat tapered design, lengths uncoil to lay flat
- No sharp kerb-effect, pedestrian friendly
- Fully safety tested and certified to BS EN 60670-1:2005

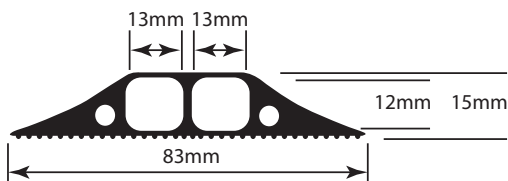

| Code        | Description  |
|-------------|--|
| FC83B/2C/9M | (L) 9.0m x (W) 83mm x (H) 15mm 2x Inner channels - (W) 13mm x (H) 12mm |

## Cable Grip Strip

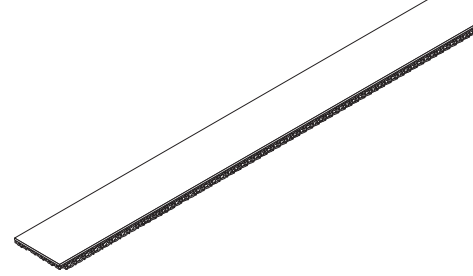

**Cable Grip Strip is a neat and easy way to keep cables in place, and to eliminate risk of cables becoming a hazard.**

Installers simply attach the Cable Grip Strip over cables. The 75mm wide x 3m long strip has hooks on rear which grip to closed-loop commercial carpet designs.

Ideal on floors under desks, or around floor perimeters, Cable Grip Strip is easy to cut and can be removed and reused as required – with no adhesive residue!

- For under desks, and perimeter of carpeted office floors
- Hook design on rear grips to commercial office carpets/carpet tiles
- Easy to remove, reusable, no adhesive residue
- Flat design, supplied coiled
- Simply scissor cut to size then pinch cables and lay over cable length(s)
- Not designed to protect cables from pedestrian traffic, but ideal to keep cables in position

| Code  | Description               |
|-------|---------------------------|
| CGS3B | (L) 3m x (W) 75mm - Black |
| CGS02 | (L) 3m x (W) 75mm - Grey  |

Caution: Cable Grip Strip should not be used on open-loop domestic type carpets, where fibres can be pulled-out on removal of the Grip Strip.

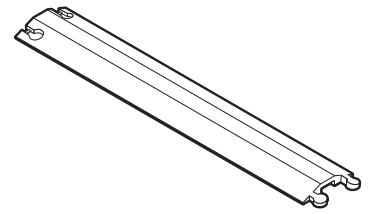

## Rigid Single Channel Cable Protector



**D-Line rigid Cable Protector lengths each have a simple and effective locking mechanism, so runs can be made in any length required.**

The extremely durable polyurethane profiles simply drop over cables up to 12mm outer diameter.

The anti-slip treads and tapered sides are pedestrian friendly, while the strength of these profiles can accept the heaviest vehicular loads permissible on UK roads.

- Made from high-grade polyurethane, extremely robust
- Join by interlocking male:female connectors
- Tapered design & non-slip treads for pedestrian traffic
- Can accept up to 11.5t Axle Weight i.e. all vehicular traffic
- Durability gives exceptional value
- Fully safety tested and certified to BS7671:2008

**DO-1B765**



Inner Channel: 38mm (W) x 12mm (H)

**DO-2B765**



Inner Channel: 45 mm (W) x 20mm (H)

| Code            | Description   |
|-----------------|---|
| <b>DO-1B765</b> | (L) 765mm x (W) 133mm x (H) 22mm Inner channel - (W) 38mm x (H) 12mm  |
| <b>DO-2B765</b> | (L) 765mm x (W) 220mm x (H) 32mm Inner channel - (W) 45 mm x (H) 20mm |

## Socket Enclosures

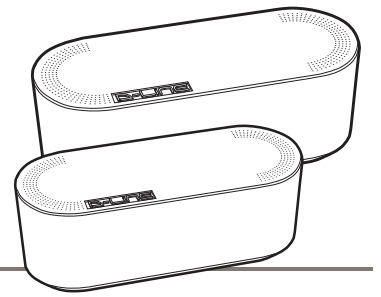

**D-Line Socket Enclosures (aka Cable Tidy Units) provide the most popular solution to contain extension sockets and cable spaghetti. The smart tech design blends with modern surroundings. 3x rear cable entry/exit slots enable cables to be routed to left-side, right-side or vertical.**

Fully safety tested, and produced from electrically-safe robust ABS material with an effective click-lock lid, these Socket Enclosures sort unsightly cables and contribute to a positive Health & Safety culture.

Use small unit to contain popular 4-gang extension sockets up to 280mm length.

Use large unit to contain popular 6-gang extension sockets up to 340mm length.

- Tidy, route & sort unsightly cable clutter
- Minimise risk of broken conductor strands
- Make socket blocks less accessible
- Prevent feet snagging cables under desks - save entanglements and costly disconnections
- Produced using electrically-safe ABS material
- Stylish & functional design. Can be used with D-Line Trunking or Zipper/Split Tube/ Spiral Wrap Accessories
- Reclaim space, so surfaces are easier to clean around
- Fully safety tested and certified to BS EN 60670-22:2006

| Code          | Description                       | Colour |
|---------------|-----------------------------------|--------|
| EU/CTUSMLB/SW | (L) 325mm x (W) 125mm x (H) 115mm | Black  |
| EU/CTUSMLW/SW | (L) 325mm x (W) 125mm x (H) 115mm | White  |
| EU/CTULGEB/SW | (L) 415mm x (W) 165mm x (H) 135mm | Black  |
| EU/CTULGEW/SW | (L) 415mm x (W) 165mm x (H) 135mm | White  |



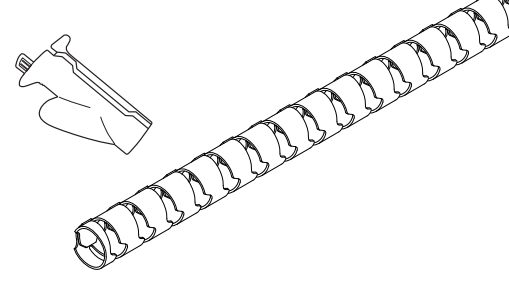

## Cable Zipper

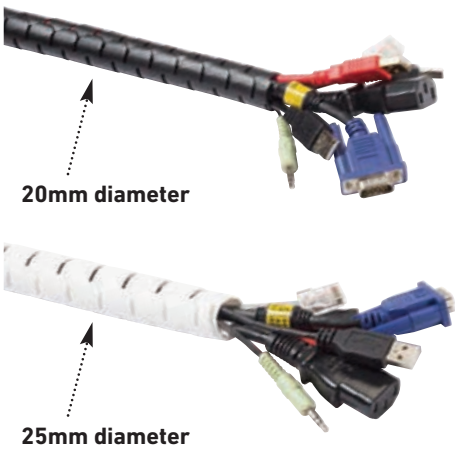

Simply place the cables in the zip tool, then pull the zip tool down along the length of the Zipper.

The cables then transfer from the tool into the length of Zipper, to provide an incredibly quick and easy way to neatly organise several cables.

The cut-outs along the length enable the Zipper to bend in tight radii. The Cable Zipper is a popular solution for residential, industrial and commercial applications.

- Ideal to conceal & protect longer runs of cables
- Quick and easy to use - scissor cut to length; insert cables in zip tool; put zip tool in to length; pull zip tool along length
- Flexible design and good resistance to oils/lubricants, acids & alkalis - suitable for use around plant and machinery too
- Zip tool included in pack
- Operating temperature -30°C to +85°C

| Code     | Description            | Colour |
|----------|------------------------|--------|
| CZ202.5B | (L) 2.5m 20mm diameter | Black  |
| CZ252.5B | (L) 2.5m 25mm diameter | Black  |
| CZ202.5W | (L) 2.5m 20mm diameter | White  |
| CZ252.5W | (L) 2.5m 25mm diameter | White  |

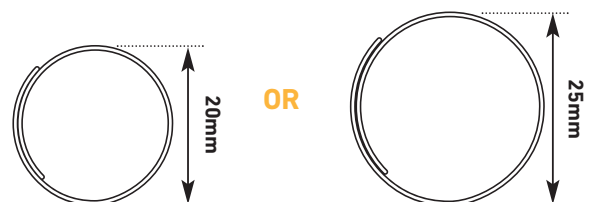



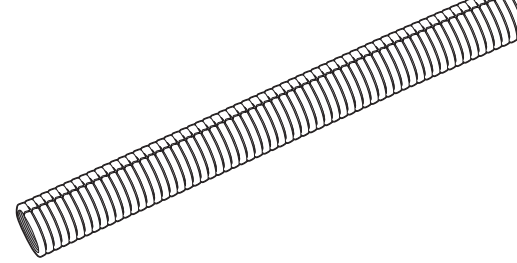

## Split Cable Tube



Cables can be manually inserted into Split Cable Tube to offer a neat way of organising a cluster of cables.

The 1.1m (3ft 7") length is ideal to sort cables dropping behind desks and TVs.

The LDPE material is very user-friendly to handle, and makes it easy to later add or remove cables.

- Tidy & protect several cables
- Ideal to contain cables dropping behind TVs and desks
- Pre-split - fits around existing cables
- Flexible & easiest to add or remove cables
- No application tool needed
- Supplied 1.1m lengths
- Fully safety tested and certified to EN 60695-2-11: 2014

| Code       | Description            | Colour |
|------------|------------------------|--------|
| CTT1.1/25B | (L) 1.1m 25mm diameter | Black  |
| CTT1.1B    | (L) 1.1m 32mm diameter | Black  |
| CTT1.1/25W | (L) 1.1m 25mm diameter | White  |
| CTT1.1W    | (L) 1.1m 32mm diameter | White  |

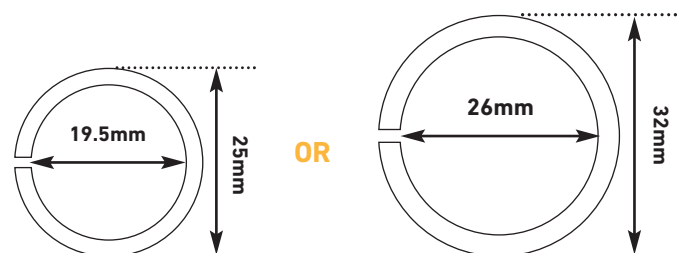

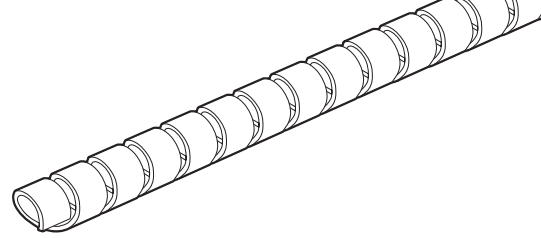

## Cable Spiral Wrap

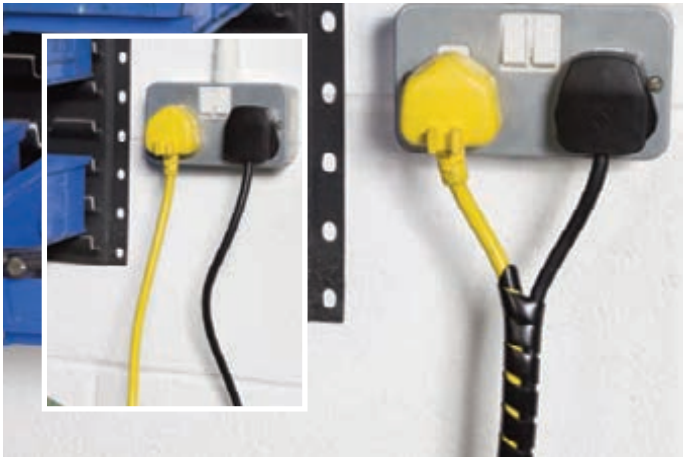

**Cable Spiral Wrap is available in 2 sizes; the larger 10mm width version can expand to contain bundles of cables up to 40mm diameter; the smaller 6mm width version can expand to contain bundles of cables up to 20mm diameter.**

Users simply wrap the Spiral around cables to give effective protection to cables.

This versatile solution allows cables to enter or exit along the length, so making a popular option for use in tight spaces.

- Versatile, easy to exit cables at any point along length
- Ideal for shorter runs of cable
- 1.5mm gauge LDPE material protects cable insulation
- Expands around bundles of cables up to 40mm diameter
- Good resistance to oils/lubricants, acids & alkalis
- Easy to cut to required length, then wrap by hand
- Fully safety tested and certified to EN 60695-2-11: 2014

| Code    | Description                   | Colour |
|---------|-------------------------------|--------|
| CTW2.5B | (L) 2.5m 10mm - 40mm diameter | Black  |
| CTW2.5W | (L) 2.5m 10mm - 40mm diameter | White  |
| CTW3B   | (L) 3m 6mm - 20mm diameter    | Black  |

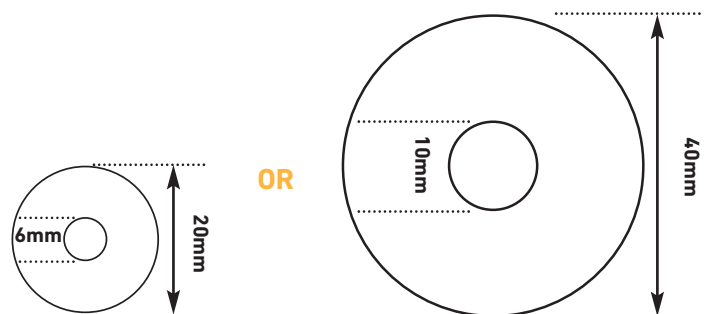

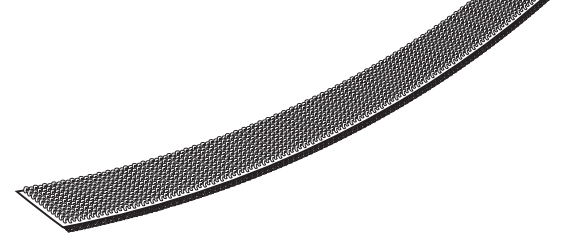

## Cable Tidy Band



**While commonly used as a reusable cable tie to secure cables to supports, this versatile hook & loop Band is ideal for multi-purpose applications.**

Fully safety-tested, Cable Tidy Band can hold up to 10kg when fastened with 50mm overlap.

A tight bind can be achieved to make a neat solution.

Being 1.2m long enables users to cut strips to required lengths.

- Tested to hold up to 10kg with a 50mm overlap
- Hook & loop design
- Scissor cut as required; Re-usable
- Versatile 1.2m length



| Code       | Description        |
|------------|--------------------|
| HLBAND1.2B | (L)1.2m x (W) 20mm |



***D-Line (Europe) Limited***

**Unit A5 Tromso Close, Tyne Tunnel Trading Estate, North Shields, Tyne & Wear NE29 7XH United Kingdom**

**Tel:** +44 (0)191 236 0960   **Sales:** +44 (0)191 237 9156   **Finance:** +44 (0)191 237 9157   **Customer Services:** +44 (0)191 237 9158

**Fax:** +44 (0)191 236 0979   **Email:** [enquiries@d-line-it.com](mailto:enquiries@d-line-it.com)   **Web:** [www.d-line-it.com](http://www.d-line-it.com)

February 2020