

# Full Motion TV Mount

DTBTA100-DL

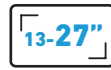

33-69cm  
Screen Size



Max VESA  
Size



Max Weight  
Capacity



Distance from  
the wall



Tilt  
Range



Turn  
Range

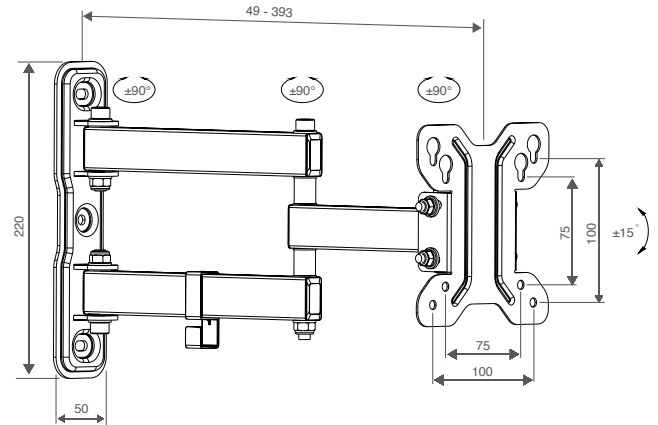
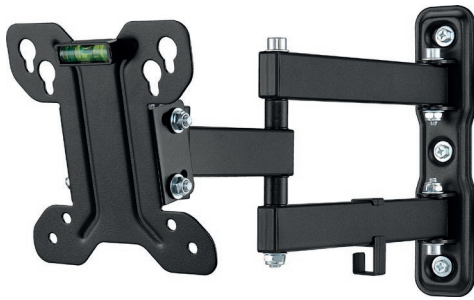

All dimensions are in mm

## Features:

- Three arms for smooth and stable movement so you can see the TV from any angle
- Ideal for desks, kitchens and corners to save space in your room
- Adjustment in all directions, so you can get the perfect screen position
- Shaped metal plate for extra strength to reliably support your TV or monitor
- Can be used to keep the screen away from children and pets
- Confidently mount your screen with a high 25kg maximum weight limit
- Suits 13" - 27" TVs, compatible with common VESA sizes 75x75 and 100x100
- Includes fixings for solid walls, stud walls and the TV, for convenience
- High quality steel construction with independent testing by SGS
- Reassurance of a 5 year warranty as standard



Compatible VESA Sizes

75x75  
100x100

## Packaging Information

Part Number	Description	Product Packaging		Outer Packaging		
		Type	Barcode	Type	Qty in box	Barcode
DTBTA100-DL	Full Motion Triple Arm TV wall mount bracket, 13 - 27"	Colour retail box	5056335606528	Brown outer with label	10	15056335606525

## Weights & Dimensions

Product			Product Box			Outer Box		
Extended	Folded	Net Weight	Dimensions	Gross Weight	Cubic	Dimensions	Gross Weight	Cubic
22.0 x 13.0 x 39.3 cm	22.0 x 24.3 x 4.9 cm	1.4kg	22.5 x 26.0 x 6.3 cm	1.51kg	0.0037m <sup>3</sup>	66.0 x 27.5 x 24.0cm	17.5kg	0.0436m <sup>3</sup>
8.66" x 5.12" x 15.47"	8.66" x 9.57" x 1.93"	3.09lbs	8.86" x 10.24" x 2.48"	3.33lbs	0.1302ft <sup>3</sup>	25.98" x 10.83" x 9.45"	38.6lbs	1.5383ft <sup>3</sup>

# Full Motion TV Wall Mount

DTBTA100-DL

## Instruction Manual

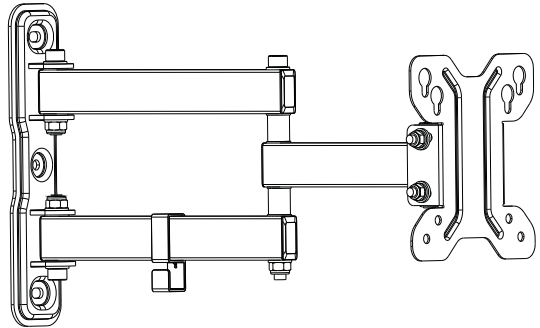

- EN** Tools required  
**FR** Outils nécessaires  
**ES** Herramientas necesarias  
**PT** Ferramentas necessárias  
**DE** Benötigtes Werkzeug  
**IT** Strumenti necessari



- EN** Set includes  
**FR** Inclut  
**ES** Incluye  
**PT** Inclui  
**DE** Lieferumfang  
**IT** Il set include

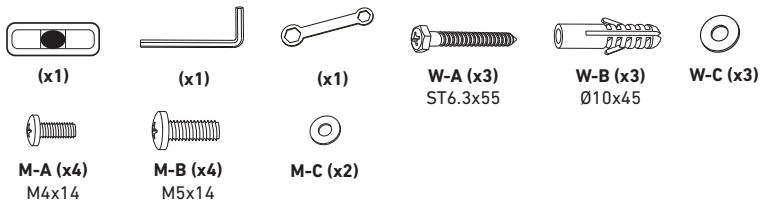

- EN** Do not overtighten screws.  
**FR** Ne pas trop serrer les vis.  
**ES** No apriete demasiado los tornillos.

- PT** Não apertar demasiado os parafusos.  
**DE** Ziehen Sie die Schrauben nicht zu fest an.  
**IT** Non serrare eccessivamente le viti.

**EN** Locate studs using a stud finder. Check for pipes and cables.

**FR** Localisez les montants à l'aide d'un détecteur mural. Vérifier la présence de tuyaux et de câbles.

**ES** Localice las vigas con un detector de pared. Compruebe si hay tuberías o cables.

**PT** Localizar as vigas com um detector de paredes. Verificar a existência de tubos e cabos.

**DE** Lokalisieren Sie die Dachsparren mit einem Wanddetektor.

Überprüfen Sie das Vorhandensein von Rohren und Kabeln.

**IT** Individuare le travi con un rilevatore a parete. Verificare la presenza di tubi e cavi.



**1a Stud wall**

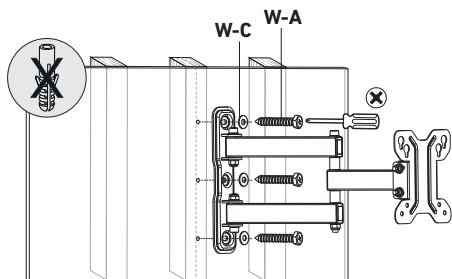
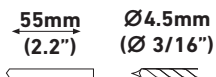
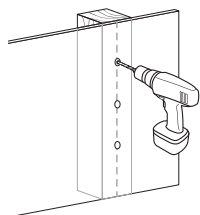
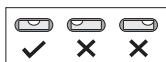
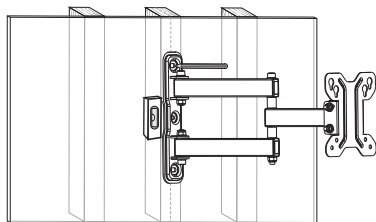

**1b Solid wall**

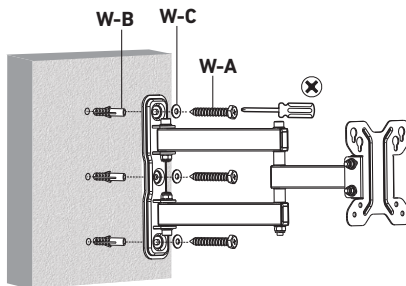
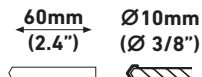
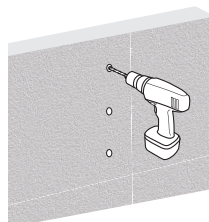
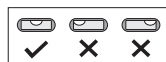
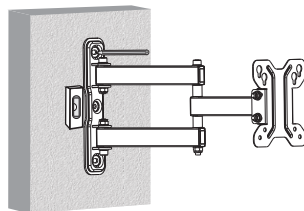

2

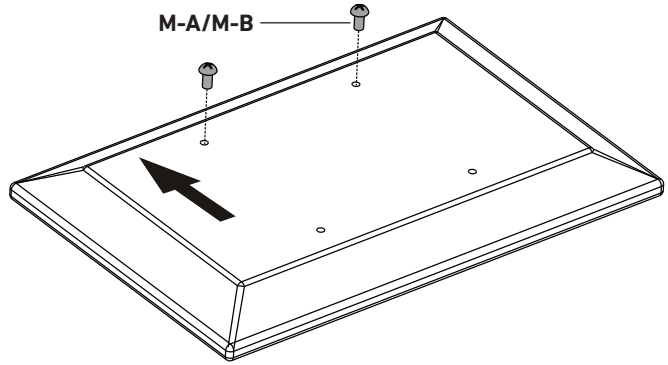
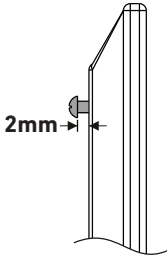

3

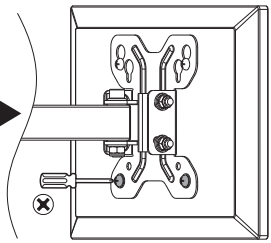
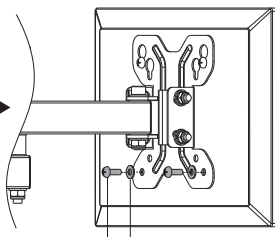
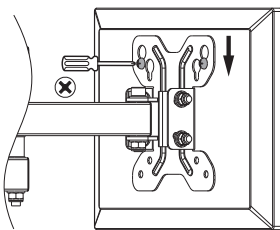
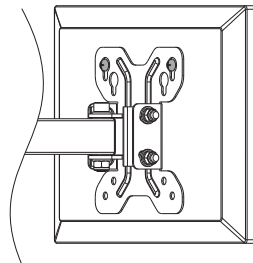
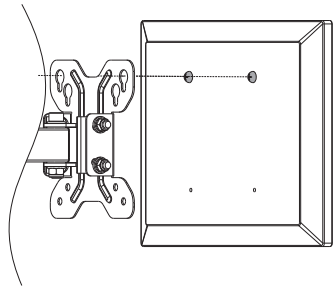

M-C  
M-A/MB

